



∞ WE ARE THE FACTORY ∞

- ◇ Product specifications are subject to change without prior notice.
- ◇ Contents, illustrations and pictures of this catalog are for demonstration purposes only and may be slightly different from the actual product. If any difference is found, the actual product prevails.
- ◇ Attention California Residents: **⚠WARNING** Products in this catalog may contain chemicals known to the State of California to cause cancer, birth defects or other reproductive harm. For more information, go to www.P65Warnings.ca.gov.



ABOUT C.A.C.

A Tradition of Service, Quality and Value

Since first established in New Jersey, U.S.A. in the 1990's, C.A.C. has dedicated to expertly fulfilling industry needs in foodservice and hospitality and strategically anticipating market trends. With steadily expanded and constantly evolving line of foodservice supplies and equipment, we are committed to providing quality products and reliable services at the best value on the market.

As an award-winning supplier of five prominent North American buying groups and a member of the *North American Association of Food Equipment Manufacturers*, C.A.C. collaborates with hundreds of foodservice dealers and chain restaurants nationwide, making our products seen almost everywhere.

Equipped with intensive experience in the industry and in-depth knowledge of customer's needs, C.A.C. has developed a comprehensive brand family over the years — C.A.C. China®, C.A.C. Stainless®, C.A.C. Aluminum®, C.A.C. Melamine®, C.A.C. Poly®, Elegant®, BlendKing®, Klinge®, Schärfe®, Schnell®, EquilThermo®, ComfyGrip®, BagTec® and Chef's Pride®.



C.A.C. provides durable dinnerware at all levels, including porcelain, fine bone china and stoneware, ideal for tabletop, cooking, baking, serving, food preparation and oven-to-table. Customers can choose from a variety of modern shapes from square, triangle to asymmetry that will brighten up all tables of every dining occasion. Additionally, C.A.C. offers Elegant®, the most economical, fully-glazed dinnerware available on the market. Fully vitrified, the Elegant collection has beautifully-glazed foot and is designed and produced to meet the highest standard of elegance, practicability and durability. Our china products are oven-, microwave- and dishwasher-safe except as otherwise noted and are break-, chip- and scratch-resistant in normal service use.

C.A.C. is proud to introduce smallwares and countertop equipment as part of our continuous efforts in offering a full-scale foodservice solution to fulfill the needs of any commercial settings such as restaurants, caterers, hotels/resorts, cruises, convention centers, schools, hospitals, nursing homes and mobile kitchens. A restaurant manager will find everything from front-of-the-house to back-of-the-house, e.g., dinnerware, tabletop, beverage/bar solution and janitorial/sanitation solution. A chef will find everything for a professional kitchen to create tasty cuisines such as cookware, GN-standard steam table pans and food pans, bakeware, pizza supplies, food preparation tools and gadgets, and countertop appliances. With a solid base in dinnerware, C.A.C. offers an extensive selection of foodservice supplies that can match with any cuisines and dining venues, turning every occasion into a memorable experience.

C.A.C. stocks 5,500+ products at any time in our multiple warehousing facilities in New Jersey. We ship orders on the same day once confirmed. Our dedicated and experienced sales/customer service team is available during regular business hours for any questions about products and orders. With warranty on selected products, we stand behind our products and services with confidence.

We are deeply grateful for all our customers and partners. Thank you for your continued patronage during our 20+ years of journey in becoming a one-stop foodservice manufacturing supplier. C.A.C. will strive to carry on our commitment to provide you with reliable services, quality products, and the best value in the decades to come.

Brand Family



TABLE OF CONTENTS

Flatware & Steak Knife 4

Royal 8001 18/8	Exquisite 8005 18/8
Elite 8002 18/8	Lux 8006 18/8
Noble 8003 18/8	Glamour 8023 18/8
Phoenix 3001 18/0	Thames 3013 18/0
Prime 3002 18/0	Celtic 3015 18/0
Continental 3003 18/0	Tulip 3033 18/0
Seine 3005 18/0	Pearl 2008 18/0
Black Pearl 3008 18/0	Dominion 1001 2001 18/0
Rhine 3010 18/0	Windsor 1002 2002 18/0
Jasmine 3011 18/0	Elizabeth 2023 2003 18/0
Iris 3012 18/0	Steak Knife

Dinnerware 22

Maxwell Melamine

Buffet & Catering Solution 24

Chafing Dish	Pasta Fork
Serving Utensil	Tong
Marmite Soup Chafer	Basting Spoon
Beverage Dispenser	Ladle

Apparel 36

Jacket & Shirt	Chef Hat
Pants	Apron

Dining Service 42

Menu Cover	Taco & Salsa Service
Order Holder	Syrup Dispenser
Service Glove	Glass Shaker
Table Cover	Oil/Vinegar Cruet
Toothpick Dispenser	Dredge
Straw Dispenser	Squeeze Bottle
Napkin Holder	Pepper Mill
Waste Bin	BagTec® Insulated Delivery Bag
Serving Tray	Countertop Protective Shield
Plate Cover	Stanchion & Sign
Serving Basket	Compliance Sign
Cake Stand & Cover	LED Sign
Cone Holder	

Beverage Solution 58

Airpot	Beverage Dispenser
Urn Coffee Maker	Wine Cooler & Stand
Insulated Beverage Server	Ice Bucket
Teapot	Stainless Steel Pitcher
Frothing Pitcher	Poly Pitcher & Tumbler
Cup/Lid Organizer	

Bar Solution 66

Speed Rail	Drip Tray
Strainer	Bar Mat
Corkscrew	Citrus Squeezer
Jigger	Straw
Cobbler Shaker	Moscow Mule Mug
Condiment Holder	Ashtray

Steam Table Pan & Food Pan 72

Steam Table Pan & Accessory	Electric Water Pan
Bain-Marie	Food Pan & Accessory
Vegetable Inset Pot	

Cookware 78

Deluxe Stainless Steel Cookware	Fry Basket
Aluminum Pro Cookware	Pan Handle Cover
Carbon Steel Wok	Pot Holder

Bakeware 87

Sheet Pan Rack & Truck	Measuring Tool
Sheet Pan & Accessory	Oven Mitt
Baking Pan	Scraper
Cake Marker	Dough Box
Pastry Cutter	Bakery Display Case
Decorating Tip	

Pizza Supply 98

Pizza Stand & Rack	Pizza Pan & Screen
--------------------	--------------------

Cutlery & Cutting Board 100

Schnell® Cutlery	Asian Cleaver
Scharfe® Cutlery	Cut-Resistant Glove
Klinge® Cutlery	Cutting Board, Rack & Brush

Kitchen Gadget 106

Disher	Skimmer
ComfyGrip® Kitchen Tool	Funnel
Portion Spoon	Whip/Whisk
Basting Spoon	Nylon Utensil
Ladle	Scoop
Turner	Grater
Strainer	Spreader

Food Preparation 116

Digital Scale	Colander
Tortilla Press	Mixing Bowl
Steak Weight	EquilThermo® Thermometer



Kitchen Equipment

120

Burger Patty Molding Press	Fruit/Vegetable Wedge Cutter
Countertop Juice Squeezer	Tomato Slicer
Vegetable Dicer	French Fry Cutter

Storage & Organization

124

Poly Storage Container & Box	Wire Cart & Accessory
Ingredient Bin	Dunnage Rack
Wire Shelving & Accessory	

Jan/San & Transporting Solution

134

Floor Mat	Range Hood Filter
Mop Bucket & Floor Sign	Cleaning Brush
Mop	Bus Box
Broom, Dust Pan	Trash Can
Cleaning Cloth & Pad	Utility Cart
Disposable Glove	Dish Caddy
Cleaning Bucket	Ice Caddy
Dishwashing Apron & Glove	Insulated Carrier

Countertop Appliance

149

Urn Coffee Maker	Heat Lamp
BlendKing® Blender	Induction Cooker
Electric Water Pan	Food & Soup Warmer
Butane Stove	Countertop Refrigerator
Hot Dog Roller Grill	Convection Oven

Merchandising Display

160

Refrigerated Case	Heated Case
-------------------	-------------

Chinaware

162



Alphabetical Index

314

 C.A.C. specialty products

SYMBOLS



Item is NSF listed and meets the food safety standards imposed by NSF International.



Item is ETL listed; meets and complies with electrical safety standards in the U.S.A. and Canada (CAN/CSA-C22.2).



Item is ETL listed; meets and complies with electrical safety standards in the U.S.A.



Item is ETL sanitation listed; complies with NSF/ANSI sanitation standards.



Item is CSA listed for use with butane gas, commercial indoor or outdoor operation in the U.S.A. and Canada.



Item is free of BPA (Bis-phenol-A).



Item is compatible with induction cook tops.



Item is free of PFOA (Perfluorooctanoic Acid).



Item has retail-ready packaging.



Ship by freight only; UPS small package not available



Item is equipped with advanced Quantum 2 non-stick coating, which is internally reinforced to withstand abrasives and high wear. It is oven-safe, dishwasher-safe and free of PFOA.



Flatware Patterns

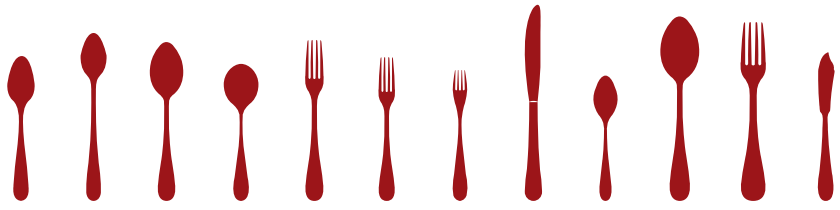

Pattern	Material	Weight	Finish	01 Teaspoon	02 Iced Tea Spoon	03 Dinner Spoon	04 Bouillon Spoon	05 Dinner Fork	06 Salad Fork	07 Oyster Fork	08 Dinner Knife	09 Demitasse Spoon	10 Tablespoon	11 Table Fork	12 Butter Spreader
1001 Dominion	18/0 S/S	MW	Frost	5-7/8"	7-7/8"	7"	6"	7-1/8"	6-1/8"	5-5/8"	8"	4-5/8"	7-5/8"		
2001 Dominion	18/0 S/S	HW	Frost	5-3/4"		7"	5-7/8"	7-1/8"	6-1/8"		7-7/8"				
1002 Windsor	18/0 S/S	MW	Frost	5-7/8"	8"	7"	6"	7"	6-1/4"	5-1/2"	8"	4-5/8"	7-5/8"		
2002 Windsor	18/0 S/S	HW	Frost	6"		7"	5-7/8"	7-1/8"	6-1/8"		8"				
2003 Elizabeth	18/0 S/S	HW	Frost	6-3/8"	8"	7-1/4"	6"	7-1/4"	6-1/2"	6"	8-5/8"	4-1/2"	8-3/8"		
2023 Elizabeth	18/0 S/S	HW	Mirror	6-3/8"		7-1/4"	6"	7-1/4"							
2008 Pearl	18/0 S/S	HW	Frost	6"		7-1/4"	6-1/4"	7-1/2"	6-1/8"		8-3/4"				
3001 Phoenix	18/0 S/S	HW	Mirror	6-3/8"	7"	7-3/8"	6-3/8"	7-5/8"	7"	6"	8-3/4"	4-5/8"	8-1/4"		7-1/8"
3002 Prime	18/0 S/S	Extra HW	Mirror	6-3/8"	7-1/2"	7-1/4"	5-7/8"	7-5/8"	7"	5-5/8"	8-3/4"	4-5/8"	8-1/4"	8"	
3003 Continental	18/0 S/S	HW	Mirror	6"		7"	5-7/8"	7-1/8"	6-1/8"		8-5/8"				
3005 Seine	18/0 S/S	HW	Satin	6-1/8"		7-1/4"	6"	7-3/4"	6-1/8"		8-3/4"				
3008 Black Pearl	18/0 S/S	HW	Mirror	6-1/4"	7-1/8"	7-3/8"	6-1/8"	7-3/8"	6-1/4"	5-5/8"	8-3/4"	4-3/4"	8-3/8"		
3010 Rhine	18/0 S/S	HW	Satin	6-1/8"		6-3/4"	6"	7-1/4"			8-1/8"				
3011 Jasmine	18/0 S/S	HW	Satin	6"	7-1/4"	7-1/4"	6"	T: 7-5/8" F: 7-1/2"	6-3/4"	5-1/2"	7-3/8"				
3012 Iris	18/0 S/S	HW	Mirror	6"		7-3/4"		7-5/8"			8-1/8"				
3013 Thames	18/0 S/S	HW	Satin	6-1/8"	7-3/4"	7-3/8"	6-1/8"	7-1/4"	6-1/2"		8-3/8"				
3015 Celtic	18/0 S/S	HW	Mirror	6-1/4"	7-1/2"	7-3/8"	6"	7-5/8"	7"	5-3/4"	9-1/4"	4-1/2"	8-1/4"	8-1/2"	6-3/4"
3033 Tulip	18/0 S/S	Extra HW	Mirror	6-1/8"		7-1/4"	6"	7-1/4"	6-7/8"	5-5/8"	9-1/8"	4-1/2"	8-1/4"	8-1/4"	
8001 Royal	18/8 S/S	Extra HW	Mirror	6-1/8"	7-7/8"	7-5/8"	6"	7-7/8"	6-3/4"	5-3/4"	8-7/8"	4-1/2"	8-3/8"	8"	6-3/4"
8002 Elite	18/8 S/S	Extra HW	Mirror	6"	7-3/8"	7-1/4"	5-7/8"	7-1/4"	6-3/4"	5-3/4"	9-1/4"	4-5/8"	8-1/4"	8"	6-3/4"
8003 Noble	18/8 S/S	Extra HW	Mirror	6-1/8"	7-1/4"	7-3/8"	6-1/4"	7-3/8"	6-3/4"	5-5/8"	9-1/8"	4-1/2"	8-1/4"	8-3/8"	6-3/4"
8005 Exquisite	18/8 S/S	Extra HW	Mirror	6"	7-3/8"	7-1/8"	7"	7-1/8"	5-7/8"	5-1/2"	9"	4-3/8"	8-5/8"	8-1/4"	6-5/8"
8006 Lux	18/8 S/S	Extra HW	Mirror	6"	7-1/2"	7-3/8"	5-7/8"	7-1/4"	6-7/8"	5-5/8"	9-1/4"	4-3/8"	8-1/4"	8-1/4"	6-3/4"
8023 Glamour	18/8 SS	Extra HW	Mirror	6"	7-1/2"	7-1/4"	5-7/8"	7-1/4"	6-1/4"	5-5/8"	9-3/8"	4-5/8"	8-1/2"	8-1/8"	6-3/4"

Formal Place Setting

Make a lasting impression
using our flatware and china.
Happy setting!



Bread Plate



Water Glass



Additional Beverage



Napkin

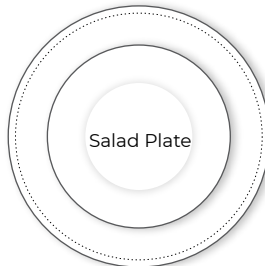

Salad Plate



Cup & Saucer



Check more china products
on page 162.



Royal 8001

◆ 18/8 Stainless Steel ◆ Extra Heavyweight ◆ Mirror Finish

Item	Description	Length	UOM	Case
8001-01	Teaspoon	6-1/8"	Doz	1/25
8001-02	Iced Tea Spoon	7-7/8"	Doz	1/25
8001-03	Dinner Spoon	7-5/8"	Doz	1/25
8001-04	Bouillon Spoon	6"	Doz	1/25
8001-05	Dinner Fork	7-7/8"	Doz	1/25
8001-06	Salad Fork	6-3/4"	Doz	1/25
8001-07	Oyster Fork	5-3/4"	Doz	1/25
8001-08	Dinner Knife	8-7/8"	Doz	1/15
8001-09	Demitasse Spoon	4-1/2"	Doz	1/25
8001-10	Tablespoon	8-3/8"	Doz	1/25
8001-11	Table Fork	8"	Doz	1/25
8001-12	Butter Spreader	6-3/4"	Doz	1/25
8001-15	Table Knife	9-5/8"	Doz	1/15







Elite 8002

◆ 18/8 Stainless Steel ◆ Extra Heavyweight ◆ Mirror Finish

Item	Description	Length	UOM	Case
8002-01	Teaspoon	6"	Doz	1/25
8002-02	Iced Tea Spoon	7-3/8"	Doz	1/25
8002-03	Dinner Spoon	7-1/4"	Doz	1/25
8002-04	Bouillon Spoon	5-7/8"	Doz	1/25
8002-05	Dinner Fork	7-1/4"	Doz	1/25
8002-06	Salad Fork	6-3/4"	Doz	1/25
8002-07	Oyster Fork	5-3/4"	Doz	1/25
8002-08	Dinner Knife	9-1/4"	Doz	1/15
8002-09	Demitasse Spoon	4-5/8"	Doz	1/25
8002-10	Tablespoon	8-1/4"	Doz	1/25
8002-11	Table Fork	8"	Doz	1/25
8002-12	Butter Spreader	6-3/4"	Doz	1/25
8002-13	Steak Knife, Pointed Tip	8-7/8"	Doz	1/15
8002-15	Table Knife	9-3/4"	Doz	1/15



Elite Serving Utensil

Item	Description	Length	UOM	Case
8002-18	Cold Meat Fork	8-1/2"	Doz	1/10
8002-17	Solid Spoon	9"	Doz	1/10
8002-19	Solid Spoon	11-1/2"	Doz	1/10
8002-20	Slotted Spoon	11-1/2"	Doz	1/10
8002-21	Banquet Fork	12"	Doz	1/10



📌 Check more serving utensils on page 30.



Noble 8003

◆ 18/8 Stainless Steel ◆ Extra Heavyweight ◆ Mirror Finish

Item	Description	Length	UOM	Case
8003-01	Teaspoon	6-1/8"	Doz	1/25
8003-02	Iced Tea Spoon	7-1/4"	Doz	1/25
8003-03	Dinner Spoon	7-3/8"	Doz	1/25
8003-04	Bouillon Spoon	6-1/4"	Doz	1/25
8003-05	Dinner Fork	7-3/8"	Doz	1/25
8003-06	Salad Fork	6-3/4"	Doz	1/25
8003-07	Oyster Fork	5-5/8"	Doz	1/25
8003-08	Dinner Knife	9-1/8"	Doz	1/15
8003-09	Demitasse Spoon	4-1/2"	Doz	1/25
8003-10	Tablespoon	8-1/4"	Doz	1/25
8003-11	Table Fork	8-3/8"	Doz	1/25
8003-12	Butter Spreader	6-3/4"	Doz	1/25



Exquisite 8005

◆ 18/8 Stainless Steel ◆ Extra Heavyweight ◆ Mirror Finish

Item	Description	Length	UOM	Case
8005-01	Teaspoon	6"	Doz	1/25
8005-02	Iced Tea Spoon	7-3/8"	Doz	1/25
8005-03	Dinner Spoon	7-1/8"	Doz	1/25
8005-04	Bouillon Spoon	7"	Doz	1/25
8005-05	Dinner Fork	7-1/8"	Doz	1/25
8005-06	Salad Fork	5-7/8"	Doz	1/25
8005-07	Oyster Fork	5-1/2"	Doz	1/25
8005-08	Dinner Knife	9"	Doz	1/15
8005-09	Demitasse Spoon	4-3/8"	Doz	1/25
8005-10	Tablespoon	8-5/8"	Doz	1/25
8005-11	Table Fork	8-1/4"	Doz	1/25
8005-12	Butter Spreader	6-5/8"	Doz	1/25





Lux 8006

◆ 18/8 Stainless Steel ◆ Extra Heavyweight ◆ Mirror Finish



Item	Description	Length	UOM	Case
8006-01	Teaspoon	6"	Doz	1/25
8006-02	Iced Tea Spoon	7-1/2"	Doz	1/25
8006-03	Dinner Spoon	7-3/8"	Doz	1/25
8006-04	Bouillon Spoon	5-7/8"	Doz	1/25
8006-05	Dinner Fork	7-1/4"	Doz	1/25
8006-06	Salad Fork	6-7/8"	Doz	1/25
8006-07	Oyster Fork	5-5/8"	Doz	1/25
8006-08	Dinner Knife	9-1/4"	Doz	1/15
8006-09	Demitasse Spoon	4-3/8"	Doz	1/25
8006-10	Tablespoon	8-1/4"	Doz	1/25
8006-11	Table Fork	8-1/4"	Doz	1/25
8006-12	Butter Spreader	6-3/4"	Doz	1/25
8006-16	Salad Knife	8-1/2"	Doz	1/25



Glamour 8023

◆ 18/8 Stainless Steel ◆ Extra Heavyweight ◆ Mirror Finish

Item	Description	Length	UOM	Case
8023-01	Teaspoon	6"	Doz	1/25
8023-02	Iced Tea Spoon	7-1/2"	Doz	1/25
8023-03	Dinner Spoon	7-1/4"	Doz	1/25
8023-04	Bouillon Spoon	5-7/8"	Doz	1/25
8023-05	Dinner Fork	7-1/4"	Doz	1/25
8023-06	Salad Fork	6-1/4"	Doz	1/25
8023-07	Oyster Fork	5-5/8"	Doz	1/25
8023-08	Dinner Knife	9-3/8"	Doz	1/15
8023-09	Demitasse Spoon	4-5/8"	Doz	1/25
8023-10	Tablespoon	8-1/2"	Doz	1/25
8023-11	Table Fork	8-1/8"	Doz	1/25
8023-12	Butter Spreader	6-3/4"	Doz	1/25





Phoenix 3001

◆ 18/0 Stainless Steel ◆ Heavyweight ◆ Mirror Finish

Item	Description	Length	UOM	Case
3001-01	Teaspoon	6-3/8"	Doz	1/25
3001-02	Iced Tea Spoon	7"	Doz	1/25
3001-03	Dinner Spoon	7-3/8"	Doz	1/25
3001-04	Bouillon Spoon	6-3/8"	Doz	1/25
3001-05	Dinner Fork	7-5/8"	Doz	1/25
3001-06	Salad Fork	7"	Doz	1/25
3001-07	Oyster Fork	6"	Doz	1/25
3001-08	Dinner Knife	8-3/4"	Doz	1/25
3001-09	Demitasse Spoon	4-5/8"	Doz	1/25
3001-10	Tablespoon	8-1/4"	Doz	1/25
3001-12	Butter Spreader	7-1/8"	Doz	1/25



Prime 3002

◆ 18/0 Stainless Steel ◆ Extra Heavyweight ◆ Mirror Finish

Item	Description	Length	UOM	Case
3002-01	Teaspoon	6-3/8"	Doz	1/25
3002-02	Iced Tea Spoon	7-1/2"	Doz	1/25
3002-03	Dinner Spoon	7-1/4"	Doz	1/25
3002-04	Bouillon Spoon	5-7/8"	Doz	1/25
3002-05	Dinner Fork	7-5/8"	Doz	1/25
3002-06	Salad Fork	7"	Doz	1/25
3002-07	Oyster Fork	5-5/8"	Doz	1/25
3002-08	Dinner Knife	8-3/4"	Doz	1/15
3002-09	Demitasse Spoon	4-5/8"	Doz	1/25
3002-10	Tablespoon	8-1/4"	Doz	1/25
3002-11	Table Fork	8"	Doz	1/25



Continental 3003

◆ 18/0 Stainless Steel ◆ Heavyweight ◆ Mirror Finish

Item	Description	Length	UOM	Case
3003-01	Teaspoon	6"	Doz	1/50
3003-03	Dinner Spoon	7"	Doz	1/50
3003-04	Bouillon Spoon	5-7/8"	Doz	1/50
3003-05	Dinner Fork	7-1/8"	Doz	1/50
3003-06	Salad Fork	6-1/8"	Doz	1/50
3003-08	Dinner Knife	8-5/8"	Doz	1/25



Seine 3005

◆ 18/0 Stainless Steel ◆ Heavyweight ◆ Satin Finish

Item	Description	Length	UOM	Case
3005-01	Teaspoon	6-1/8"	Doz	1/50
3005-03	Dinner Spoon	7-1/4"	Doz	1/50
3005-04	Bouillon Spoon	6"	Doz	1/50
3005-05	Dinner Fork	7-3/4"	Doz	1/50
3005-06	Salad Fork	6-1/8"	Doz	1/50
3005-08	Dinner Knife	8-3/4"	Doz	1/25





Black Pearl 3008

◆ 18/0 Stainless Steel ◆ Heavyweight ◆ Mirror Finish

Item	Description	Length	UOM	Case
3008-01	Teaspoon	6-1/4"	Doz	1/50
3008-02	Iced Tea Spoon	7-1/8"	Doz	1/50
3008-03	Dinner Spoon	7-3/8"	Doz	1/50
3008-04	Bouillon Spoon	6-1/8"	Doz	1/50
3008-05	Dinner Fork	7-3/8"	Doz	1/50
3008-06	Salad Fork	6-1/4"	Doz	1/50
3008-07	Oyster Fork	5-5/8"	Doz	1/50
3008-08	Dinner Knife	8-3/4"	Doz	1/25
3008-09	Demitasse Spoon	4-3/4"	Doz	1/50
3008-10	Tablespoon	8-3/8"	Doz	1/25

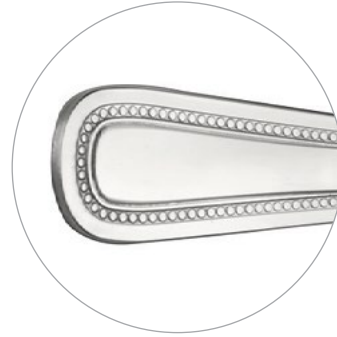

Rhine 3010

◆ 18/0 Stainless Steel ◆ Heavyweight ◆ Satin Finish

Item	Description	Length	UOM	Case
3010-01	Teaspoon	6-1/8"	Doz	1/50
3010-03	Dinner Spoon	6-3/4"	Doz	1/50
3010-04	Bouillon Spoon	6"	Doz	1/50
3010-05	Dinner Fork	7-1/4"	Doz	1/50
3010-08	Dinner Knife	8-1/8"	Doz	1/25



Jasmine 3011

◆ 18/0 Stainless Steel ◆ Heavyweight ◆ Satin Finish

Item	Description	Length	UOM	Case
3011-01	Teaspoon	6"	Doz	1/50
3011-02	Iced Tea Spoon	7-1/4"	Doz	1/50
3011-03	Dinner Spoon	7-1/4"	Doz	1/50
3011-04	Bouillon Spoon	6"	Doz	1/50
3011-05T	Dinner Fork, 3-Tine	7-5/8"	Doz	1/50
3011-05F	Dinner Fork, 4-Tine	7-1/2"	Doz	1/50
3011-06	Salad Fork	6-3/4"	Doz	1/50
3011-07	Oyster Fork	5-1/2"	Doz	1/50
3011-08	Dinner Knife	7-3/8"	Doz	1/25



Iris 3012

◆ 18/0 Stainless Steel ◆ Heavyweight ◆ Mirror Finish

Item	Description	Length	UOM	Case
3012-01	Teaspoon	6"	Doz	1/50
3012-03	Dinner Spoon	7-3/4"	Doz	1/50
3012-05	Dinner Fork	7-5/8"	Doz	1/50
3012-08	Dinner Knife	8-1/8"	Doz	1/25





Thames 3013

◆ 18/0 Stainless Steel ◆ Heavyweight ◆ Satin Finish

Item	Description	Length	UOM	Case
3013-01	Teaspoon	6-1/8"	Doz	1/50
3013-02	Iced Tea Spoon	7-3/4"	Doz	1/50
3013-03	Dinner Spoon	7-3/8"	Doz	1/50
3013-04	Bouillon Spoon	6-1/8"	Doz	1/50
3013-05	Dinner Fork	7-1/4"	Doz	1/50
3013-06	Salad Fork	6-1/2"	Doz	1/50
3013-08	Dinner Knife	8-3/8"	Doz	1/25



Celtic 3015

◆ 18/0 Stainless Steel ◆ Heavyweight ◆ Mirror Finish

Item	Description	Length	UOM	Case
3015-01	Teaspoon	6-1/4"	Doz	1/25
3015-02	Iced Tea Spoon	7-1/2"	Doz	1/25
3015-03	Dinner Spoon	7-3/8"	Doz	1/25
3015-04	Bouillon Spoon	6"	Doz	1/25
3015-05	Dinner Fork	7-5/8"	Doz	1/25
3015-06	Salad Fork	7"	Doz	1/25
3015-07	Oyster Fork	5-3/4"	Doz	1/25
3015-08	Dinner Knife	9-1/4"	Doz	1/15
3015-09	Demitasse Spoon	4-1/2"	Doz	1/25
3015-10	Tablespoon	8-1/4"	Doz	1/25
3015-11	Table Fork	8-1/2"	Doz	1/25
3015-12	Butter Spreader	6-3/4"	Doz	1/25



Tulip 3033

◆ 18/0 Stainless Steel ◆ Extra Heavyweight ◆ Mirror Finish

Item	Description	Length	UOM	Case
3033-01	Teaspoon	6-1/8"	Doz	1/25
3033-03	Dinner Spoon	7-1/4"	Doz	1/25
3033-04	Bouillon Spoon	6"	Doz	1/25
3033-05	Dinner Fork	7-1/4"	Doz	1/25
3033-06	Salad Fork	6-7/8"	Doz	1/25
3033-07	Oyster Fork	5-5/8"	Doz	1/25
3033-08	Dinner Knife	9-1/8"	Doz	1/15
3033-09	Demitasse Spoon	4-1/2"	Doz	1/25
3033-10	Table Spoon	8-1/4"	Doz	1/15
3033-11	Table Fork	8-1/4"	Doz	1/15



Pearl 2008

◆ 18/0 Stainless Steel ◆ Heavyweight ◆ Frost Finish

Item	Description	Length	UOM	Case
2008-01	Teaspoon	6"	Doz	1/50
2008-03	Dinner Spoon	7-1/4"	Doz	1/50
2008-04	Bouillon Spoon	6-1/4"	Doz	1/50
2008-05	Dinner Fork	7-1/2"	Doz	1/50
2008-06	Salad Fork	6-1/8"	Doz	1/50
2008-08	Dinner Knife	8-3/4"	Doz	1/25



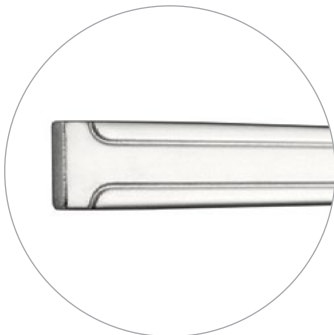

Dominion Dinner Knife

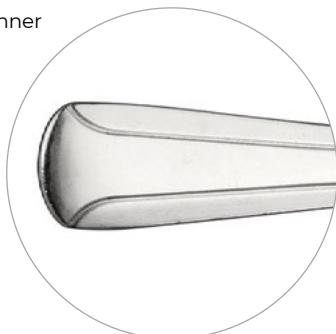

Rest Dominion Series

Dominion 1001

◆ 18/0 Stainless Steel ◆ Medium Weight ◆ Frost Finish

Item	Description	Length	UOM	Case
1001-01	Teaspoon	5-7/8"	Doz	1/50
1001-02	Iced Tea Spoon	7-7/8"	Doz	1/50
1001-03	Dinner Spoon	7"	Doz	1/50
1001-04	Bouillon Spoon	6"	Doz	1/50
1001-05	Dinner Fork	7-1/8"	Doz	1/50
1001-06	Salad Fork	6-1/8"	Doz	1/50
1001-07	Oyster Fork	5-5/8"	Doz	1/50
1001-08	Dinner Knife	8"	Doz	1/25
1001-09	Demitasse Spoon	4-5/8"	Doz	1/50
1001-10	Tablespoon	7-5/8"	Doz	1/25

Dominion 2001

◆ 18/0 Stainless Steel ◆ Heavyweight ◆ Frost Finish

Item	Description	Length	UOM	Case
2001-01	Teaspoon	5-3/4"	Doz	1/50
2001-03	Dinner Spoon	7"	Doz	1/50
2001-04	Bouillon Spoon	5-7/8"	Doz	1/50
2001-05	Dinner Fork	7-1/8"	Doz	1/50
2001-06	Salad Fork	6-1/8"	Doz	1/50
2001-08	Dinner Knife	7-7/8"	Doz	1/25



Windsor 1002

◆ 18/0 Stainless Steel ◆ Medium Weight ◆ Frost Finish

Item	Description	Length	UOM	Case
1002-01	Teaspoon	5-7/8"	Doz	1/50
1002-02	Iced Tea Spoon	8"	Doz	1/50
1002-03	Dinner Spoon	7"	Doz	1/50
1002-04	Bouillon Spoon	6"	Doz	1/50
1002-05	Dinner Fork	7"	Doz	1/50
1002-06	Salad Fork	6-1/4"	Doz	1/50
1002-07	Oyster Fork	5-1/2"	Doz	1/50
1002-08	Dinner Knife	8"	Doz	1/25
1002-09	Demitasse Spoon	4-5/8"	Doz	1/50
1002-10	Tablespoon	7-5/8"	Doz	1/25

Windsor 2002

◆ 18/0 Stainless Steel ◆ Heavyweight ◆ Frost Finish

Item	Description	Length	UOM	Case
2002-01	Teaspoon	6"	Doz	1/50
2002-03	Dinner Spoon	7"	Doz	1/50
2002-04	Bouillon Spoon	5-7/8"	Doz	1/50
2002-05	Dinner Fork	7-1/8"	Doz	1/50
2002-06	Salad Fork	6-1/8"	Doz	1/50
2002-08	Dinner Knife	8"	Doz	1/25



Windsor Dinner Knife

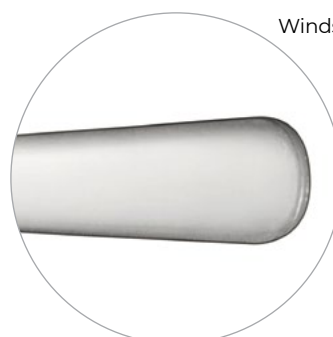

Rest Windsor Series



Elizabeth 2023

◆ 18/0 Stainless Steel ◆ Heavyweight ◆ Mirror Finish

Item	Description	Length	UOM	Case
2023-01	Teaspoon	6-3/8"	Doz	1/50
2023-03	Dinner Spoon	7-1/4"	Doz	1/50
2023-04	Bouillon Spoon	6"	Doz	1/50
2023-05	Dinner Fork	7-1/4"	Doz	1/50

Elizabeth 2003

◆ 18/0 Stainless Steel ◆ Heavyweight ◆ Frost Finish

Item	Description	Length	UOM	Case
2003-01	Teaspoon	6-3/8"	Doz	1/50
2003-02	Iced Tea Spoon	8"	Doz	1/50
2003-03	Dinner Spoon	7-1/4"	Doz	1/50
2003-04	Bouillon Spoon	6"	Doz	1/50
2003-05	Dinner Fork	7-1/4"	Doz	1/50
2003-06	Salad Fork	6-1/2"	Doz	1/50
2003-07	Oyster Fork	6"	Doz	1/50
2003-08	Dinner Knife	8-5/8"	Doz	1/25
2003-09	Demitasse Spoon	4-1/2"	Doz	1/50
2003-10	Tablespoon	8-3/8"	Doz	1/25

Steak Knife

C.A.C. Steak Knife Series offers a wide selection of functional steak knives from stainless steel handle to wooden handle and plastic handle.

- Durable yet lightweight design for long-lasting performance and convenient use
- Serrated stainless steel blade easily slices through steak or other food.
- Available in pointed tip and round tip



Serrated
Stainless Steel Blade



Multiple Choices of
Curved-Contour Handles

Steak Knife with Stainless Steel Handle

Item	Description	Blade	UOM	Case
SKS1-01R	Round Tip	4-1/2"	Doz	1/24
SKS1-02P	Pointed Tip	4-1/2"	Doz	1/24



SKS1-01R



SKS1-02P



KWSK-40



KWSK-45



KWSK-46



SKW2-01P



KWSK-50



KWSK-55



KESK-50



KESK-55



SKP3-01PF



KPSK-50F



SKP3-02P



KPSK-50



SKP3-03PF

Steak Knife with Wooden Handle

- Wooden handle with slightly-curved contours for comfortable grip

Item	Description	Blade	UOM	Case
KWSK-40	Pointed Tip	4"	Doz	1/48
KWSK-45	Round Tip	4-1/4"	Doz	1/48
KWSK-46	Pointed Tip	4-3/4"	Doz	1/48
SKW2-01P	Pointed Tip	4-3/4"	Doz	6/12
KWSK-50	Round Tip, Jumbo	5"	Doz	1/12
KWSK-55	Pointed Tip, Jumbo	5"	Doz	1/12

Steak Knife with Plastic Handle

- Plastic handle with slightly-curved contours for comfortable grip

Item	Description	Blade	UOM	Case
KESK-50	Pointed Tip	5"	Doz	1/48
KESK-55	Round Tip	5"	Doz	1/48
SKP3-01PF	Pointed Tip, Full Tang	4-1/2"	Doz	1/24
KPSK-50F	Round Tip, Full Tang	5"	Doz	1/25
SKP3-02P	Pointed Tip, Jumbo	5"	Doz	6/12
KPSK-50	Round Tip, Jumbo	5"	Doz	1/12

Slim Euro Style Steak Knife

- Triple riveted ABS plastic handle

Item	Description	Blade	UOM	Case
SKP3-03PF	Pointed Tip, Full Tang	4-1/2"	Doz	1/24



Maxwell Melamine

- Lightweight yet break-resistant melamine
- Economy choice for high-volume commercial use
- Stain- and odor-resistant; dishwasher safe
- BPA free
- Sold by case



Rolled Edge

Item	Description	Size	Capacity	UOM	Case
MLSI-8-P	Sierra Mug W	3"	8oz	Doz	4
MLRN-11	Fruit Dish	4-7/8"	5oz	Doz	4
MLRN-10	Grapefruit Dish	6-5/8"	13oz	Doz	4
MLRN-4	Bouillon	4-1/8"	8oz	Doz	4
MLRN-3	Rim Soup Plate	9"	10oz	Doz	2
MLRN-120	Pasta Bowl	12"	22oz	Doz	1
MLRN-5	Plate R.E.	5-1/2"	-	Doz	4
MLRN-6	Plate R.E.	6-1/2"	-	Doz	4
MLRN-7	Plate R.E.	7-1/8"	-	Doz	3
MLRN-8	Plate R.E.	9"	-	Doz	2
MLRN-9	Plate R.E.	9-3/4"	-	Doz	2
MLRN-16	Plate R.E.	10-1/2"	-	Doz	2
MLRN-21	Plate R.E.	12"	-	Doz	1
MLRN-12	Oval Platter R.E.	10-3/8" x 7-3/8"	-	Doz	2
MLRN-13	Oval Platter R.E.	11-1/2" x 8-1/4"	-	Doz	2
MLRN-14	Oval Platter R.E.	12-1/2" x 8-7/8"	-	Doz	2



Narrow Rim



Item	Description	Size	Capacity	UOM	Case
MLNC-1	Cup Short	3-3/4"	7.5oz	Doz	4
MLNC-2	Saucer For MLNC-1	5-1/2"	-	Doz	4
MLNC-11	Fruit Dish	4-3/4"	5oz	Doz	4
MLNC-6	Plate N.R.	6-1/2"	-	Doz	4
MLNC-7	Plate N.R.	7-1/4"	-	Doz	3
MLNC-8	Plate N.R.	9"	-	Doz	2
MLNC-9	Plate N.R.	9-3/4"	-	Doz	2
MLNC-16	Plate N.R.	10-1/4"	-	Doz	2
MLNC-12	Oval Platter N.R.	9-3/4" x 6-3/4"	-	Doz	2
MLNC-13	Oval Platter N.R.	11-1/2" x 8"	-	Doz	2
MLNC-14	Oval Platter N.R.	13-1/4" x 9-5/8"	-	Doz	1



Ramekin

- Sold by dozen



Item	Description	Size	Capacity	UOM	Case
MRKF-1	White	2-1/2"	1.5oz	Doz	1/8
MRKF-2	White	2-7/8"	2oz	Doz	1/8
MRKF-3	White	3-1/8"	3oz	Doz	1/8
MRKF-4	White	3-1/4"	4oz	Doz	1/8
MRKF-6	White	3-7/8"	6oz	Doz	1/8
MRKF-1-BLK	Black	2-1/2"	1.5oz	Doz	1/8
MRKF-2-BLK	Black	2-7/8"	2oz	Doz	1/8
MRKF-3-BLK	Black	3-1/8"	3oz	Doz	1/8
MRKF-4-BLK	Black	3-1/4"	4oz	Doz	1/8
MRKF-6-BLK	Black	3-7/8"	6oz	Doz	1/8



MRKF-4-BLK



MRKF-6



Buffet Chafing Dish

C.A.C. Buffet Chafing Dish Series is designed to keep food warm and ready-to-serve. Made of durable stainless steel, C.A.C. chafing dishes are warp-, heat-, rust-, and corrosion-resistant with long-lasting performance and maximized portability. Compatible with multiple configurations of standard GN food pans, C.A.C. Buffet Chafing Dish Series offers excellent versatility and a wide selection of appearances, shapes and colors, making them ideal for various venues such as buffets, catering services, banquets, meetings and more.

Oasis

Brighten up your dining occasion with this high polished chafing dish!

Oasis

- Warp-, heat-, rust-, and corrosion-resistant stainless steel body, cover and frame for reinforced durability and added serving longevity
- Gold accent handle pairs well with sturdy stainless steel body while adding a chic touch to any occasions.
- Timeless style with modern appearance and roll-top cover elevates every dining venue to a new level with improved convenience.
- Compatible with multiple configurations of standard GN food pans, ideal for various occasions such as buffets, catering services, hotel breakfast buffets, banquets, meetings and more
- Each set includes 1 food pan, 1 water pan, 1 cover, and 2 fuel holders.
- Replacement parts are available for purchase.

Item	Description	UOM	Case
CAFR-401	8QT Full Size	Set	1
CAFR-401CR	Roll-Top Cover for 401	Each	1
CAFR-WP	Full Size Water Pan for 401	Each	6
STPF-S25-2	Full Size GN Food Pan for 401, NSF	Each	6/12
CAFR-FH	Fuel Holder with Cover	Each	12/48



CAFR-401



Gold Accent Handle



CAFR-401CR



CAFR-WP



STPF-S25-2



CAFR-FH

Atlantis

- Warp-, heat-, rust-, and corrosion-resistant stainless steel body, cover and frame for reinforced durability and added serving longevity
- Roll-top cover opens 180° with generous full-size holding capacity for added convenience and reduced refills
- Minimalistic and monochromatic style with high polished body and streamlined handle easily blends into any fine dining occasions.
- Compatible with multiple configurations of standard GN food pans, ideal for various occasions such as buffets, catering services, hotel breakfast buffets, banquets, meetings and more
- Each set includes 1 food pan, 1 water pan, 1 cover, and 2 fuel holders for CAFR-501 or 1 fuel holder for CAFR-503.
- Replacement parts are available for purchase.

Atlantis
 Accentuate your dining occasion
 with timeless aesthetic of this chafing dish!

Item	Description	UOM	Case
CAFR-501	8QT Full Size	Set	1
CAFR-503	6QT Round	Set	1
CAFR-WP	Full Size Water Pan for 501	Each	6
CAFR-503WP	Round Water Pan for 503	Each	12
STPF-S25-2	Full Size GN Food Pan for 501, NSF	Each	6/12
CAFR-503FP	Round Food Pan for 503	Each	12
CAFR-503FP-D	Round Divided Food Pan for 503	Each	10
CAFR-FH	Fuel Holder with Cover	Each	12/48



180° Opening Roll-Top Cover



CAFR-501



CAFR-503WP



CAFR-503FP



CAFR-503



CAFR-501 & BF-102 x2



CAFR-503 & BF-R16

Check more compatible china food pans on page 274.

LUMINOUS

Classic Chafing Dish

with
Gold Accent and Gleaming Mirror Finish



CAFR-203



CAFR-205



CAFR-201



Luminous

- Warp-, heat-, rust-, and corrosion-resistant stainless steel body, cover and frame for daily use
- Built-on back hooks of full-size chafer hold cover in place when serving and refilling; top handle and two side-handles allow for safe operation and transporting
- Gold accent handle and frame with shimmering finish will add a charm to every dining venue.
- Compatible with multiple configurations of standard GN food pans, ideal for various occasions such as catering services, hotel breakfast buffets, banquets and more
- Each set includes 1 food pan, 1 water pan, 1 cover, and 2 fuel holders for full-size and oval chafers or 1 fuel holder for round chafer.
- Replacement parts are available for purchase.

Item	Description	UOM	Case
CAFR-201	8QT Full Size	Set	1
CAFR-205	6QT Oval	Set	1
CAFR-203	4QT Round	Set	1
CAFR-WP	Full Size Water Pan for 201	Each	6
CAFR-205WP	Oval Water Pan for 205	Each	12
CAFR-203WP	Round Water Pan for 203	Each	12
STPF-S25-2	Full Size GN Food Pan for 201, NSF	Each	6/12
CAFR-205FP	Oval Food Pan for 205	Each	12
CAFR-203FP	Round Food Pan for 203	Each	12
CAFR-FH	Fuel Holder with Cover	Each	12/48

Welsh

- Warp-, heat-, rust-, and corrosion-resistant stainless steel body, cover and frame for long-lasting performance
- Decorative lid handle along with finely-sculpted legs and silver-like, polished exterior perfect for formal dining
- Finely-sculpted side handles in wooden-color add stability during transporting while fulfilling aesthetic purposes.
- Beveled legs with non-skid cap allow for secure operation during service; elevated bottom tray ensures proper heating distance.
- Compatible with multiple configurations of standard GN food pans, ideal for various occasions such as catering services, hotel breakfast buffets, meetings and more
- Each set includes 1 food pan, 1 water pan, 1 cover, and 2 fuel holders for full-size chafer or 1 fuel holder for round and square chafers.
- Replacement parts are available for purchase.

Item	Description	UOM	Case
CAFR-301 	8QT Full Size	Set	1
CAFR-303 	6QT Round	Set	1
CAFR-307 	4QT Square	Set	1
CAFR-WP	Full Size Water Pan for 301	Each	6
CAFR-303WP	Round Water Pan for 303	Each	6
CAFR-307WP	Square Water Pan for 307	Each	6
STPF-S25-2	Full Size GN Food Pan for 301, NSF	Each	6/12
CAFR-303FP	Round Food Pan for 303	Each	6
CAFR-307FP	Square Food Pan for 307	Each	12
CAFR-FH	Fuel Holder with Cover	Each	12/48

Welsh
*Elegant Chafing Dish with
 Decorative Handle and Shimmering Mirror Finish*



CAFR-303



CAFR-307





CAFR-301

.. Modish ..

Modish

- Convenient serving and refilling with a professional look
- Light in weight with foldable frame (101) or fixed frame (102) for easy transporting and convenient storage
- Built-on back hooks hold cover in place when serving and refilling; cool-touch top handle and two side-handles allow for safe operation and transporting.
- Each set includes 1 full size GN food pan, 1 full size water pan, 1 cover, and 2 fuel holders.
- Replacement parts are available for purchase.

Item	Description	UOM	Case
CAFR-101 	8QT Full Size, Foldable Frame	Set	1
CAFR-102 	8QT Full Size, Fixed Frame	Set	1
CAFR-WP	Full Size Water Pan for 101/102	Each	6
STPF-S25-2	Full Size GN Food Pan for 101/102, NSF	Each	6/12
CAFR-FH	Fuel Holder with Cover	Each	12/48



CAFR-101



CAFR-102



CAFR-102



Full Size Water Pan & GN Food Pan & Cover



Foldable Frame

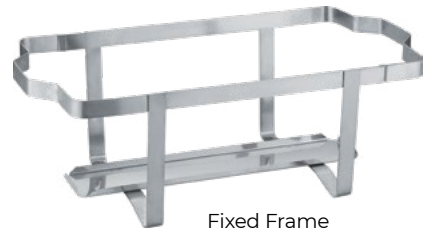

Fixed Frame



SBFH-SO01



SBFH-SL02



SBFH-SN03



SBFH-FP04



SBFH-FM05



SBFH-LS06



SBFH-LS07



SBFH-LD08



SBFH-ST09



SBFH-SP10



SBFH-TP11



SBFH-SK12



SBFH-KS13

Hollow Handle Buffetware

- Elegant design with mirror finish blends well with any upscale dining environment.
- Corrosion- and scratch-resistant stainless steel construction for long-lasting performance
- Curved finger grips on handle for comfortable and secure operation

Item	Description	Length	UOM	Case
SBFH-SO01	Solid Spoon	11-3/4"	Each	12/72
SBFH-SL02	Slotted Spoon	11-3/4"	Each	12/72
SBFH-SN03	Notched Spoon	11-3/4"	Each	12/72
SBFH-FP04	Pot Fork	11-3/8"	Each	12/72
SBFH-FM05	Cold Meat Fork	10-3/8"	Each	12/72
SBFH-LS06	Spout Ladle, 1 oz	12"	Each	12/72
SBFH-LS07	Spout Ladle, 2 oz	13"	Each	12/72
SBFH-LD08	Deep Ladle, 4 oz	13-1/8"	Each	12/72
SBFH-ST09	Pastry Server	11"	Each	12/72
SBFH-SP10	Pie Server	12-1/4"	Each	12/72
SBFH-TP11	Perforated Turner	14-1/2"	Each	12/72
SBFH-SK12	Skimmer, 4-1/2" Dia	14-3/8"	Each	12/72
SBFH-KS13	Serrated Knife	13-7/8"	Each	12/72





Elite Serving Utensil

- 18/8 stainless steel
- Extra heavyweight
- Mirror finish

Item	Description	Length	UOM	Case
8002-18	Cold Meat Fork	8-1/2"	Doz	1/10
8002-17	Solid Spoon	9"	Doz	1/10
8002-19	Solid Spoon	11-1/2"	Doz	1/10
8002-20	Slotted Spoon	11-1/2"	Doz	1/10
8002-21	Banquet Fork	12"	Doz	1/10



Louvre Serving Utensil

- Extra heavyweight stainless steel
- Mirror finish

Item	Description	Length	UOM	Case
3023-17	Solid Spoon	11-3/4"	Each	12/120
3023-19	Solid Spoon	13"	Each	12/120
3023-35	Pot Fork	13"	Each	12/120
3023-36	Ladle, 1oz	7"	Doz	1/18
3023-37	Ladle, 2oz	9-1/4"	Each	12/120
3023-38	Ladle, 4oz	11-1/2"	Each	12/120



Serving Spoon

- Heavyweight stainless steel
- Mirror finish

Item	Description	Length	UOM	Case
SSLs-8	Solid Spoon	8-1/2"	Doz	1/20
SSLs-8F	Solid Spoon, Flat Edge	8-1/2"	Doz	1/20



Auspicious Serving Utensil

- 18/8 stainless steel
- Extra heavyweight
- Mirror finish

Item	Description	Length	UOM	Case
8015-18	Cold Meat Fork	8-1/2"	Doz	1/10
8015-17	Solid Spoon	9"	Doz	1/10
8015-22	Slotted Spoon	9"	Doz	1/10
8015-19	Solid Spoon	11-1/2"	Doz	1/10
8015-20	Slotted Spoon	11-1/2"	Doz	1/10
8015-21	Banquet Fork	12"	Doz	1/10

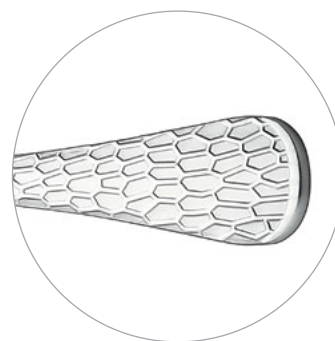



CAMS-107

CAMS-111

Marmite Soup Chafer

- Simple yet modern look in mirror finish coordinates well with all dining occasions.
- Warp-, heat-, rust-, and corrosion-resistant stainless steel construction for enhanced durability and increased serving longevity
- Two sturdy handle allow for safe operation and easy transporting.
- Ideal for keeping warm soup, stew and sauce at buffets, catering events, banquets and more
- Each set includes 1 soup bucket, 1 water pan, 1 cover, 1 frame, and 1 fuel holder.
- Replacement parts are available for purchase.

Item	Description	UOM	Case
CAMS-107	7QT Warmer Set	Set	1
CAMS-111	11QT Warmer Set	Set	1
CAMS-107WP	Water Pan for CAMS-107	Each	12
CAMS-111WP	Water Pan for CAMS-111	Each	12
INSS-70F	Inset for CAMS-107	Each	6/24
INSS-110F	Inset for CAMS-111	Each	6/12
INSS-70C	Cover for CAMS-107	Each	6/48
INSS-110C	Cover for CAMS-111	Each	6/36
INSS-70CH	Hinged Cover for CAMS-107	Each	6/24
INSS-110CH	Hinged Cover for CAMS-111	Each	6/24
CAFR-FH	Fuel Holder with Cover	Each	12/48



BVDS-J2G

BVDS-J2S

Beverage Dispenser

- Mirror finish lid and stand with clear polycarbonate container add a sleek and elegant touch.
- Break-resistant container with corrosion-resistant ice core for long-lasting performance
- Center ice core when filled with ice keeps beverage cold for hours without watering down the beverage.
- Ideal for holding and dispensing lemonade, tea, juice, sangria, water and more
- Removable drip tray, lid, ice core, and container for easy refills and cleaning
- Replacement faucet and container are available for purchase separately.

Item	Description	UOM	Case
BVDS-J2S	2.2 Gallon, Silver SS/PC	Set	1
BVDS-J2G	2.2 Gallon, Silver/Gold SS/PC	Set	1
BVDS-J2FT	Faucet for BVDS-J2 Series	Each	12/48
BVDS-J2CTN	Clear Container for BVDS-J2 Series	Each	4

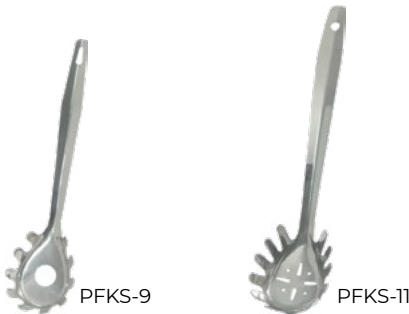

PFKS-9

PFKS-11

Pasta Fork

- Constructed with stainless steel and long handle, great for serving

Item	Description	UOM	Case
PFKS-9	9"	Each	12/144
PFKS-11	11"	Each	12/144

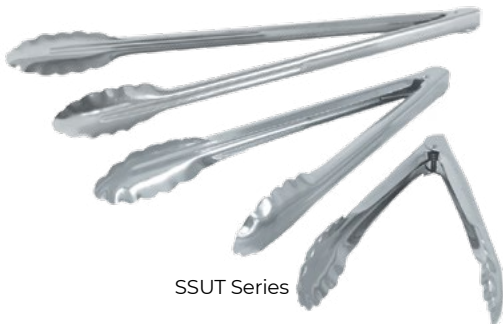

SSUT Series

Stainless Steel Utility Tong

- Coiled spring design

Item	Description	UOM	Case
SSUT-9-05	9-1/2"	Each	12/72
SSUT-12-05	12"	Each	12/72
SSUT-16-05	16"	Each	12/72
SSUT-9-10	9-1/2", Heavy-Duty	Each	12/72
SSUT-12-10	12", Heavy-Duty	Each	12/72
SSUT-16-10	16", Heavy-Duty	Each	12/72
SSUT-9-12	9-1/2", Extra Heavy-Duty	Each	12/72
SSUT-12-12	12", Extra Heavy-Duty	Each	12/72
SSUT-16-12	16", Extra Heavy-Duty	Each	12/72

18/8 Serving Tong

- Made of 18/8 stainless steel for optimal rust- and corrosion-resistance and added strength
- Classic and ergonomic design for comfortable grip
- Perfect choice for formal settings, catering services, buffets, and any indoor or outdoor venues
- Easy to clean and maintain; dishwasher safe

Item	Description	Finish	UOM	Case
STG1-9	8-1/2", Serving	Satin	Each	12/72
STG1-11	10-1/2", Serving	Satin	Each	12/72
STG1-14	13-5/8", Serving	Satin	Each	12/72
STG2-10D	10", Double Spoon Scissor	Mirror	Each	6/60
STG2-10F	10", Fork/Spoon Scissor	Satin	Each	6/60
STG2-10U	10", Slotted/Solid Spatula Scissor	Mirror	Each	12/96
STG2-11P	10-1/2", Perf. Pastry Scissor	Mirror	Each	12/96
S3TG-BR7	7", Bar	Mirror	Each	12/72
S3TG-PM9	9", Pom	Mirror	Each	12/72
S3TG-12	12", Serving	Mirror	Each	12/72
S3TG-O12	12", Offset Serving	Mirror	Each	12/72



STG2-10D



STG2-10F



STG2-10U



STG2-11P



STG1-9



STG1-11



STG1-14



S3TG-BR7



S3TG-PM9



S3TG-12



S3TG-O12

Stainless Steel Tong

Item	Description	UOM	Case
SPMT-6	6", Pom	Each	12/120
SPMT-9	9", Pom	Each	12/120
SPMT-12	12", Pom	Each	12/120
SICT-7	7", Ice	Each	12/72
SERT-7	7-1/4", Serrated	Each	12/72
SPGT-8	8", Spaghetti	Each	12/144



SPMT-6



SPGT-8



SERT-7



SICT-7



STCH-10BK



STCH-12BL



STCH-12RD



STCH-12GN



STCH-16YL



UTKU-6C



UTKU-6BK



UTKU-12R



UTKU-12BG



STKU-11BG



STKU-11C

Color-Coded Utility Tong

- Heavy-duty stainless steel construction ideal for cold food service
- Color-coded handle helps avoid cross contamination for enhanced sanitation.

Item	Description	Color	UOM	Case
STCH-10RD	10"	Red	Each	12/72
STCH-10GN	10"	Green	Each	12/72
STCH-10BK	10"	Black	Each	12/72
STCH-10BL	10"	Blue	Each	12/72
STCH-10YL	10"	Yellow	Each	12/72
STCH-12RD	12"	Red	Each	12/72
STCH-12GN	12"	Green	Each	12/72
STCH-12BK	12"	Black	Each	12/72
STCH-12BL	12"	Blue	Each	12/72
STCH-12YL	12"	Yellow	Each	12/72
STCH-16RD	16"	Red	Each	12/72
STCH-16GN	16"	Green	Each	12/72
STCH-16BK	16"	Black	Each	12/72
STCH-16BL	16"	Blue	Each	12/72
STCH-16YL	16"	Yellow	Each	12/72

Polycarbonate Utility Tong

- Durable polycarbonate construction ideal for daily high-volume use
- Smooth surface for comfortable grip and easy cleaning
- NSF listed



Item	Description	UOM	Case
UTKU-6BG	6", Beige	Each	12/192
UTKU-6C	6", Clear	Each	12/192
UTKU-6BK	6", Black	Each	12/192
UTKU-6R	6", Red	Each	12/192
UTKU-9BG	9", Beige	Each	12/144
UTKU-9C	9", Clear	Each	12/144
UTKU-9BK	9", Black	Each	12/144
UTKU-9R	9", Red	Each	12/144
UTKU-12BG	12", Beige	Each	12/144
UTKU-12C	12", Clear	Each	12/144
UTKU-12BK	12", Black	Each	12/144
UTKU-12R	12", Red	Each	12/144

Polycarbonate Spaghetti Tong

- Durable polycarbonate construction ideal for daily high-volume use
- Secure grasp and easy serving
- NSF listed



Item	Description	UOM	Case
STKU-11BG	11", Beige	Each	24/144
STKU-11C	11", Clear	Each	24/144
STKU-11R	11", Red	Each	24/144

Basting Spoon

–One-piece stainless steel construction

Item	Description	Thickness	UOM	Case
SBHS-11	11", Solid	1.2mm	Each	12/144
SBHP-11	11", Perforated	1.2mm	Each	12/144
SBHL-11	11", Slotted	1.2mm	Each	12/144
SBHS-13	13", Solid	1.2mm	Each	12/144
SBHP-13	13", Perforated	1.2mm	Each	12/144
SBHL-13	13", Slotted	1.2mm	Each	12/144
SBHS-15	15", Solid	1.2mm	Each	12/144
SBHP-15	15", Perforated	1.2mm	Each	12/144
SBHL-15	15", Slotted	1.2mm	Each	12/144
SBSO-18	18", Solid	1.5mm	Each	12/72
SBSP-18	18", Perforated	1.5mm	Each	12/72
SBSO-21	21", Solid	1.5mm	Each	12/72
SBSP-21	21", Perforated	1.5mm	Each	12/72



Basting Spoon with Black Handle

–One-piece stainless steel construction

–Plastic handle with finger hook for secure and comfortable grip

Item	Description	Thickness	UOM	Case
SBSO-11BH	11" Solid	1.2mm	Each	12/72
SBSP-11BH	11" Perforated	1.2mm	Each	12/72
SBSL-11BH	11" Slotted	1.2mm	Each	12/72
SBSO-13BH	13" Solid	1.2mm	Each	12/72
SBSP-13BH	13" Perforated	1.2mm	Each	12/72
SBSL-13BH	13" Slotted	1.2mm	Each	12/72
SBSO-15BH	15" Solid	1.2mm	Each	12/72
SBSP-15BH	15" Perforated	1.2mm	Each	12/72
SBSL-15BH	15" Slotted	1.2mm	Each	12/72



Ladle

–One-piece stainless steel construction

Item	Description	Length	UOM	Case
SSLD-05	0.5oz	11-1/4"	Each	12/240
SSLD-10	1oz	11-1/4"	Each	12/240
SSLD-20	2oz	11-7/8"	Each	12/120
SSLD-30	3oz	12-5/8"	Each	12/120
SSLD-40	4oz	14"	Each	12/120
SSLD-60	6oz	14-3/8"	Each	12/120
SSLD-80	8oz	14-3/4"	Each	12/120
SSLD-120	12oz	15-1/8"	Each	12/120
SSLD-160	16oz	15-1/2"	Each	12/120



Ladle with Color-Coded Handle

–One-piece stainless steel construction

–Color-coded handle for easy recognition and portion control

Item	Description	Length	UOM	Case
SSLD-05GN	0.5oz, Green	11-3/8"	Each	12/120
SSLD-10BK	1oz, Black	11-1/2"	Each	12/120
SSLD-20BL	2oz, Blue	12"	Each	12/120
SSLD-30IV	3oz, Ivory	12-3/4"	Each	12/120
SSLD-40GY	4oz, Gray	14-1/8"	Each	12/120
SSLD-60TL	6oz, Teal	14-3/4"	Each	12/120
SSLD-80OR	8oz, Orange	14-7/8"	Each	12/60
SSLD-120RD	12oz, Red	13-3/8"	Each	12/60



SSLD Series



Chef's Pride Apparel

C.A.C. Chef's Pride Apparel Series is designed and made to withstand tough industrial needs. With an assortment from chef jackets, chef shirts, chef pants to server aprons, C.A.C. Chef's Pride Series is a perfect solution for functional, comfortable, and affordable culinary apparel that looks professional with great agility.

- 65/35 poly/cotton fabric
- Strong, durable, breathable, wrinkle- and shrink-resistant
- Machine wash and tumble dry for easy maintenance



APST Series

Chef Shirt

-Snap button

Item	Description	UOM	Case
APST-8KS	Black, Small	Each	24/48
APST-8KM	Black, Medium	Each	24/48
APST-8KL	Black, Large	Each	24/48
APST-8KIXL	Black, XL	Each	24/48
APST-8K2XL	Black, 2XL	Each	24/48
APST-9WS	White, Small	Each	24/48
APST-9WM	White, Medium	Each	24/48
APST-9WL	White, Large	Each	24/48
APST-9WIXL	White, XL	Each	24/48
APST-9W2XL	White, 2XL	Each	24/48

Size chart

	Small	Medium	Large	XL	2XL
Chest 	36" - 39"	40" - 43"	44" - 46"	47" - 49"	50" - 53"

CARE INSTRUCTIONS





Chef Jacket

- Double-breasted button front
- One sleeve split pocket that fits pen, thermometer, or other small tools
- Black jacket features pointed collar and square French cuff.
- White jacket features round collar and angled French cuff.

Item	Description	UOM	Case
APJK-1KS	Black, Small	Each	12/24
APJK-1KM	Black, Medium	Each	12/24
APJK-1KL	Black, Large	Each	12/24
APJK-1K1XL	Black, XL	Each	12/24
APJK-1K2XL	Black, 2XL	Each	12/24
APJK-2WS	White w/ Chest Pocket, Small	Each	12/24
APJK-2WM	White w/ Chest Pocket, Medium	Each	12/24
APJK-2WL	White w/ Chest Pocket, Large	Each	12/24
APJK-2W1XL	White w/ Chest Pocket, XL	Each	12/24
APJK-2W2XL	White w/ Chest Pocket, 2XL	Each	12/24



APJK Series



Size chart

	Small	Medium	Large	XL	2XL
Chest 	35" - 38"	39" - 42"	43" - 46"	47" - 50"	51" - 54"

CARE INSTRUCTIONS





APPT Series

Chef Pants

- 2 side seam pockets; 2 back patch pockets
- Elastic waistband with drawstring

Item	Description	UOM	Case
APPT-1KS	Black, Small	Each	12/24
APPT-1KM	Black, Medium	Each	12/24
APPT-1KL	Black, Large	Each	12/24
APPT-1K1XL	Black, XL	Each	12/24
APPT-1K2XL	Black, 2XL	Each	12/24
APPT-2HS	Houndstooth, Small	Each	12/24
APPT-2HM	Houndstooth, Medium	Each	12/24
APPT-2HL	Houndstooth, Large	Each	12/24
APPT-2H1XL	Houndstooth, XL	Each	12/24
APPT-2H2XL	Houndstooth, 2XL	Each	12/24

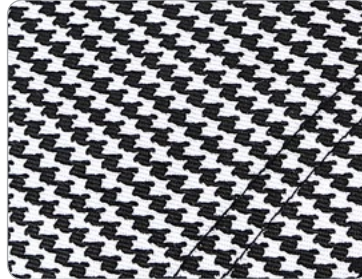

Houndstooth Pattern



Side Seam Pocket





Back Patch Pocket



Elastic Waistband with Drawstring

Size chart

		Small	Medium	Large	XL	2XL
Waist		28" - 30"	32" - 34"	36" - 38"	40" - 42"	44" - 46"
Hip		38" - 40"	42" - 44"	46" - 48"	50" - 52"	54" - 56"
Inseam		30"	31"	32"	33"	33"

CARE INSTRUCTIONS



Pillbox Chef Hat

- Mesh top for great ventilation
- Elastic back closure for a comfortable fit

Item	Description	UOM	Case
APHT-1KM	Black, S/M	Each	48/96
APHT-1KL	Black, L/XL	Each	48/96
APHT-1WM	White, S/M	Each	48/96
APHT-1WL	White, L/XL	Each	48/96
APHT-1RM	Red, S/M	Each	48/96
APHT-1RL	Red, L/XL	Each	48/96



Hook-and-Loop Closure



Elastic Back Closure







Floppy Toque Chef Hat

- One size fits most.
- Hook-and-loop closure for a secure yet easy-to-adjust fit

Item	Description	UOM	Case
APHT-2WT	White	Each	24/96
APHT-2BK	Black	Each	24/96
APHT-2BL	Blue	Each	24/96
APHT-2GN	Green	Each	24/96
APHT-2LG	Light Green	Each	24/96
APHT-2RD	Red	Each	24/96
APHT-2BR	Bright Red	Each	24/96



Size chart

	Pillbox Chef Hat S/M	Pillbox Chef Hat L/XL	Floppy Toque Chef Hat
Circumferences	 22-1/2" - 23-1/2"	 23-1/2" - 25-1/4"	 20-1/2" - 24"
Height	 3-1/2"	 3-1/2"	 13"

CARE INSTRUCTIONS





APBS-1K

Full Length Bistro Apron 🛒

- One size fits most; 28-1/2"W x 31"L
- 2 large 8-1/2"W x 9"H patch pockets
- Long waist ties for an adjustable fit

Item	Description	UOM	Case
APBS-1K	Black	Each	12/60
APBS-1W	White	Each	12/60



APBB-1W

Full Length Bib Apron 🛒

- One size fits most; 26"W x 33"L
- Classic and timeless design in black or white

Item	Description	UOM	Case
APBB-1W	White, w/o Pocket	Each	12/60
APBB-1K	Black, w/o Pocket	Each	12/60



Full Length Bib Apron with Pocket 🛒

- One size fits most; 26"W x 33"L
- Chest pocket and waist pocket
- Long waist ties for an adjustable fit
- Vibrant colors

Item	Description	UOM	Case
APBB-2WT	White, w/ Pocket	Each	12/60
APBB-2BK	Black, w/ Pocket	Each	12/60
APBB-2BL	Blue, w/ Pocket	Each	12/60
APBB-2GN	Green, w/ Pocket	Each	12/60
APBB-2RD	Red, w/ Pocket	Each	12/60
APBB-2YL	Yellow, w/ Pocket	Each	12/60



APBB-2BK
*Contents not included

APBB-2GN

APBB-2WT

APBB-2BL

APBB-2YL

APBB-2RD

■ CARE INSTRUCTIONS



Mid-Length Bib Apron

- One size fits most; 27-1/2"W x 24"L
- Adjustable neck strap and long waist ties for a customizable fit
- 3 functional front pockets

Item	Description	UOM	Case
APBB-3W	White	Each	12/60
APBB-3K	Black	Each	12/60



Adjustable Neck Strap



3 Functional Front Pockets



APBB-3K

Waist Apron with 3 Pockets

- One size fits most; 21-7/8"W x 12-1/2"L
- 3 front pockets perfect for holding waiter/waitress supplies
- Convenient length for maximized mobility

Item	Description	UOM	Case
APWA-1W	White	Each	12/60
APWA-1K	Black	Each	12/60
APWA-1R	Red	Each	12/60
APWA-1G	Green	Each	12/60



APWA-1W

APWA-1K

APWA-1G

APWA-1R

CARE INSTRUCTIONS



Clear Pocket Menu Cover

- Clear pocket with high visibility protects menu inside from liquid spill and food mess; double-sided view for every pocket
- Easy wipe clean with brass border protection for effortless maintenance and enhanced durability
- Simple design with stylish trim in elegant colors; a wide selection of panels, sizes and colors available to support your menu creation



Stylish Trim



MCP1-911GN



MCP2-911BY



MCP3-911RD



MCP4-911BK



MCP6-911GN

1-Pocket Menu Cover

-1-pocket fits 1 insert with 2 views.

Item	Description	Color	UOM	Case
MCP1-58BK	8-1/2" x 5-1/2" Insert	Black	Each	25/200
MCP1-58BY	8-1/2" x 5-1/2" Insert	Burgundy	Each	25/200
MCP1-58RD	8-1/2" x 5-1/2" Insert	Red	Each	25/200
MCP1-58GN	8-1/2" x 5-1/2" Insert	Green	Each	25/200
MCP1-911BK	8-1/2" x 11" Letter Size Insert	Black	Each	25/200
MCP1-911BY	8-1/2" x 11" Letter Size Insert	Burgundy	Each	25/200
MCP1-911RD	8-1/2" x 11" Letter Size Insert	Red	Each	25/200
MCP1-911GN	8-1/2" x 11" Letter Size Insert	Green	Each	25/200
MCP1-911BL	8-1/2" x 11" Letter Size Insert	Blue	Each	25/200
MCP1-914BK	8-1/2" x 14" Legal Size Insert	Black	Each	25/100
MCP1-914BY	8-1/2" x 14" Legal Size Insert	Burgundy	Each	25/100
MCP1-914RD	8-1/2" x 14" Legal Size Insert	Red	Each	25/100
MCP1-914GN	8-1/2" x 14" Legal Size Insert	Green	Each	25/100

2-Pocket Menu Cover

-2-pocket book-fold style fits 2 inserts with 4 views.

Item	Description	Color	UOM	Case
MCP2-911BK	8-1/2" x 11" Letter Size Insert	Black	Each	25/100
MCP2-911BY	8-1/2" x 11" Letter Size Insert	Burgundy	Each	25/100
MCP2-911RD	8-1/2" x 11" Letter Size Insert	Red	Each	25/100
MCP2-911GN	8-1/2" x 11" Letter Size Insert	Green	Each	25/100
MCP2-911BL	8-1/2" x 11" Letter Size Insert	Blue	Each	25/100
MCP2-914BK	8-1/2" x 14" Legal Size Insert	Black	Each	25/100
MCP2-914BY	8-1/2" x 14" Legal Size Insert	Burgundy	Each	25/100
MCP2-914RD	8-1/2" x 14" Legal Size Insert	Red	Each	25/100
MCP2-914GN	8-1/2" x 14" Legal Size Insert	Green	Each	25/100

3-Pocket Menu Cover

-3-pocket tri-fold style fits 3 inserts with 6 views.

Item	Description	Color	UOM	Case
MCP3-911BK	8-1/2" x 11" Letter Size Insert	Black	Each	25/50
MCP3-911BY	8-1/2" x 11" Letter Size Insert	Burgundy	Each	25/50
MCP3-911RD	8-1/2" x 11" Letter Size Insert	Red	Each	25/50
MCP3-911GN	8-1/2" x 11" Letter Size Insert	Green	Each	25/50
MCP3-911BL	8-1/2" x 11" Letter Size Insert	Blue	Each	25/50

4-Pocket Menu Cover

-4-pocket fits 4 inserts with 8 views.

Item	Description	Color	UOM	Case
MCP4-911BK	8-1/2" x 11" Letter Size Insert	Black	Each	25/50

6-Pocket Menu Cover

-6-pocket fits 6 inserts with 12 views.
- Ideal for menu with a large variety of items

Item	Description	Color	UOM	Case
MCP6-911BK	8-1/2" x 11" Letter Size Insert	Black	Each	10/50
MCP6-911BY	8-1/2" x 11" Letter Size Insert	Burgundy	Each	10/50
MCP6-911RD	8-1/2" x 11" Letter Size Insert	Red	Each	10/50
MCP6-911GN	8-1/2" x 11" Letter Size Insert	Green	Each	10/50

Faux Leather Menu Cover

- Made of highly durable faux leather for easy wipe clean and long-lasting use.
- Protects menu inside from liquid spill and food mess
- Sleek design with a professional look matches with any restaurant themes or table settings.
- A wide selection of panels, sizes and colors available to support your menu creation

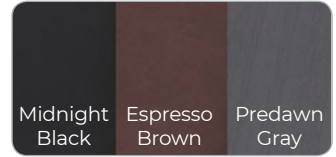

1-Panel Menu Cover

-Single panel fits 1 insert.

Item	Description	Color	UOM	Case
MCC1-514BK	4-1/2" x 14" Bar Size Insert	Black	Each	50
MCC1-11BK	8-1/2" x 11" Letter Size Insert	Black	Each	50
MCC1-11BN	8-1/2" x 11" Letter Size Insert	Brown	Each	50
MCC1-11GY	8-1/2" x 11" Letter Size Insert	Gray	Each	50
MCC1-14BK	8-1/2" x 14" Legal Size Insert	Black	Each	50
MCC1-14BN	8-1/2" x 14" Legal Size Insert	Brown	Each	50
MCC1-14GY	8-1/2" x 14" Legal Size Insert	Gray	Each	50



MCC1-11BK



Picture Corner

2-Panel Menu Cover

-2 panels fit 2 inserts.

Item	Description	Color	UOM	Case
MCC2-11BK	8-1/2" x 11" Letter Size Insert	Black	Each	30
MCC2-11BN	8-1/2" x 11" Letter Size Insert	Brown	Each	30
MCC2-11GY	8-1/2" x 11" Letter Size Insert	Gray	Each	30
MCC2-14BK	8-1/2" x 14" Legal Size Insert	Black	Each	30
MCC2-14BN	8-1/2" x 14" Legal Size Insert	Brown	Each	30
MCC2-14GY	8-1/2" x 14" Legal Size Insert	Gray	Each	30



MCC2-11 Series

4-Panel Menu Cover

-4 panels fit 4 inserts.

Item	Description	Color	UOM	Case
MCC4-11BK	8-1/2" x 11" Letter Size Insert	Black	Each	30
MCC4-11BN	8-1/2" x 11" Letter Size Insert	Brown	Each	30
MCC4-11GY	8-1/2" x 11" Letter Size Insert	Gray	Each	30
MCC4-14BK	8-1/2" x 14" Legal Size Insert	Black	Each	30
MCC4-14BN	8-1/2" x 14" Legal Size Insert	Brown	Each	30
MCC4-14GY	8-1/2" x 14" Legal Size Insert	Gray	Each	30



MCC2-14GY



MCC4-14BN

Faux Leather Menu Tent

- 2-panel or 3-panel with picture corners accommodates 5" x 7" inserts.
- Made of highly durable faux leather for long-lasting use
- Compact and eye-catching tent design matches with any restaurant themes or table settings.
- Ideal for advertising drinks, desserts, daily specials, happy hour specials and more

Item	Description	UOM	Case
MCT2-75BK	2-Panel	Each	50
MCT3-75BK	3-Panel	Each	50



MCT2-75BK



MCT3-75BK



CABL Series

Call Bell 🛒

- Loud and clear ring
- Portable and lightweight
- Sleek look with chrome finish

Item	Description	UOM	Case
CABL-3	3-1/2" Dia	Each	12/144
CABL-4	4" Dia	Each	12/72



STRV-52



STNS-32

Table Tent Sign

- Stainless steel tent sign with a professional look

Item	Description	UOM	Case
STRV-52	Reserved, 4-3/4" x 2"H	Each	12/120
STNS-32	No Smoking Symbol, 2-1/2" x 2"H	Each	12/240



Glass-Like Visibility



ACTH-53

ACTH-64

ACTH-75

ACTH-118

Menu/Card Holder

- Durable acrylic construction with glass-like visibility
- Accommodate standard size insert with double-sided view
- Easy load and unload in compact size
- BPA free



Item	Description	UOM	Case
ACTH-53	5-1/2" x 3-1/2" Insert	Each	12/48
ACTH-64	4" x 6" Insert	Each	12/36
ACTH-75	5" x 7" Insert	Each	12/36
ACTH-118	8-1/2" x 11" Insert	Each	12/24



CKSV-5K

Guest Check Presenter/Order Holder 🛒

- Liquid-proof cover protects items inside from liquid spill and food mess.
- Made of highly durable faux leather for long-lasting use

Item	Description	UOM	Case
CKPR-10K	10" x 5-1/2"	Each	12/96
CKPR-9K	8-1/2" x 5-1/4"	Each	12/96
CKSV-5K	9" x 4-1/2", 4 Pockets	Each	12/96



CKPR-9K

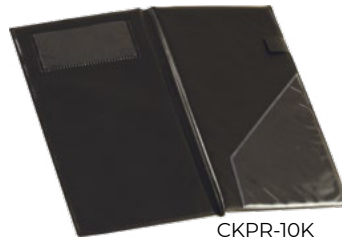

CKPR-10K

*Contents not included



GLCT Series

Service Glove 🛒

- 100% cotton; soft; comfortable; breathable
- Ambidextrous

Item	Description	Color	UOM	Case
GLCT-1M	Medium	White	Doz	1/100
GLCT-1L	Large	White	Doz	1/100

Table Cover

- Water- and tearing-resistant vinyl with Gingham pattern
- Flannel back protects table from scratch.
- Easy care and wipe clean
- Ideal for both indoor and outdoor occasions
- Vibrant colors and multiple sizes available

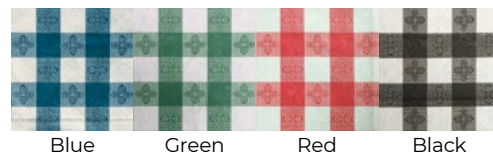

Item	Description	Color	UOM	Case
TCVG-52B	52" x 52"	Blue	Each	24
TCVG-52G	52" x 52"	Green	Each	24
TCVG-52R	52" x 52"	Red	Each	24
TCVG-52K	52" x 52"	Black	Each	24
TCVG-7052B	70" x 52"	Blue	Each	24
TCVG-7052G	70" x 52"	Green	Each	24
TCVG-7052R	70" x 52"	Red	Each	24
TCVG-7052K	70" x 52"	Black	Each	24
TCVG-9052B	90" x 52"	Blue	Each	24
TCVG-9052G	90" x 52"	Green	Each	24
TCVG-9052R	90" x 52"	Red	Each	24
TCVG-9052K	90" x 52"	Black	Each	24



Toothpick Dispenser

- Durable acrylic construction with glass-like visibility
- Sanitary dispensing with convenient top-loading
- Holds standard-sized toothpicks
- BPA free



Item	Description	UOM	Case
ACTP-8	3-1/4"L x 3"W x 5"H	Each	6/36



Straw Dispenser

- See-through, durable acrylic construction
- Top-loading and easy dispensing
- Holds straws in standard size
- BPA free



Item	Description	UOM	Case
ACSW-11H	10-3/4" x 4-3/4" x 7", Horizontal	Each	1/6



Napkin Holder

- Stainless steel tall-fold style
- 2-side opening provides convenient access.
- Easy dispensing with spring-loaded design
- Non-slip rubber feet for added stability
- NPHD-6 holds napkins up to 3-3/4"W x 5-1/8"; NPHD-8 holds napkins up to 3-3/4"W x 6-3/4"

Item	Description	UOM	Case
NPHD-6	5-1/2"H	Each	1/36
NPHD-8	7-3/8"H	Each	1/36



Table Crumber

- Helpful tool to clean crumbs off tabletop
- Convenient pocket clip

Item	Description	Color	UOM	Case
TCBA-6GD	Aluminum, 6"	Gold	Each	120/600
TCBA-6SL	Aluminum, 6"	Silver	Each	120/600



Tabletop Waste Bin

- Stainless steel construction
- Portable in compact countertop size with a sleek look

Item	Description	UOM	Case
SSWB-6	5-1/8"Dia x 6-5/8"H, Swing Top	Each	1/12





DSPT Series

Fast Food/Cafeteria Tray

- Lightweight yet durable plastic construction ideal for fast-paced dining occasions
- Skid-resistant surface for safe transporting

Item	Description	Color	UOM	Case
DSPT-1216R	16" x 12"	Red	Each	12/48
DSPT-1216K	16" x 12"	Black	Each	12/48
DSPT-1216OR	16" x 12"	Orange	Each	12/48
DSPT-1216B	16" x 12"	Blue	Each	12/48
DSPT-1216G	16" x 12"	Green	Each	12/48
DSPT-1418R	18" x 14"	Red	Each	12/48
DSPT-1418K	18" x 14"	Black	Each	12/48
DSPT-1418OR	18" x 14"	Orange	Each	12/48
DSPT-1418B	18" x 14"	Blue	Each	12/48
DSPT-1418G	18" x 14"	Green	Each	12/48

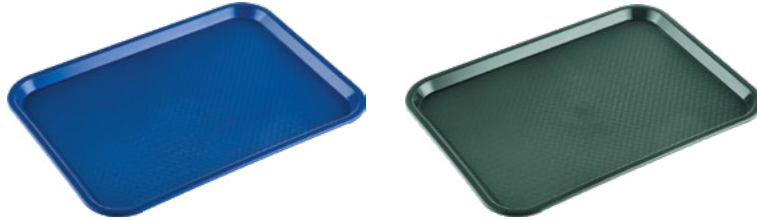

FGT & PDT Series

Non-Slip Fiberglass Tray

- High-impact fiberglass construction and reinforced rim for enhanced durability
- Stain- and odor-resistant surface perfect for daily use
- NSF listed



Item	Description	Color	UOM	Case
FGTR-11BK	11", Round	Black	Each	12
FGTR-11BN	11", Round	Brown	Each	12
FGTR-14BK	14", Round	Black	Each	12
FGTR-14BN	14", Round	Brown	Each	12
FGTR-16BK	16", Round	Black	Each	12
FGTR-16BN	16", Round	Brown	Each	12
FGTD-1216BK	16 x 12", Rect.	Black	Each	12
FGTD-1216BN	16 x 12", Rect.	Brown	Each	12
FGTD-1418BK	18 x 14", Rect.	Black	Each	12
FGTD-1418BN	18 x 14", Rect.	Brown	Each	12
FGTD-1520BK	20 x 15", Rect.	Black	Each	12
FGTD-1520BN	20 x 15", Rect.	Brown	Each	12
FGTO-2722BK	27 x 22", Oval	Black	Each	6
FGTO-2722BN	27 x 22", Oval	Brown	Each	6

Super Plastic Tray

- NSF listed



Item	Description	Color	UOM	Case
PDTR-11BK	11", Round	Black	Each	12
PDTR-11BN	11", Round	Brown	Each	12
PDTR-14BK	14", Round	Black	Each	12
PDTR-14BN	14", Round	Brown	Each	12
PDTR-16BK	16", Round	Black	Each	12
PDTR-16BN	16", Round	Brown	Each	12
PDTD-1418BK	18" x 14", Rect.	Black	Each	12
PDTD-1418BN	18" x 14", Rect.	Brown	Each	12
PDTO-2722BK	27" x 22", Oval	Black	Each	6
PDTO-2722BN	27" x 22", Oval	Brown	Each	6

Round Serving Tray

–Stainless steel

Item	Description	UOM	Case
SSST-13	13-3/4"	Each	12/48
SSST-15	15-3/4"	Each	12/24
SSST-17	17-3/4"	Each	12/24



SSST Series

Oval Platter

–Stainless steel

Item	Description	UOM	Case
SSPL-12-OV	11-3/4" x 8"	Each	10/60
SSPL-14-OV	13-1/2" x 8-3/8"	Each	10/60
SSPL-16-OV	15-3/4" x 10-5/8"	Each	10/40
SSPL-18-OV	17-5/8" x 11-5/8"	Each	10/30
SSPL-20-OV	19-3/4" x 13-5/8"	Each	10/20
SSPL-22-OV	21-3/8" x 14-7/8"	Each	12



SSPL Series



AUDS-8

Au Gratin Dish

–Mirror finish, stainless steel body with classic scallop-shaped handles
–Oven safe great for kitchen-to-table service

Item	Description	UOM	Case
AUDS-8	8oz	Each	12/120
AUDS-12	12oz	Each	12/144
AUDS-15	15oz	Each	12/120
AUDS-20	20oz	Each	12/72



STRY-6R

Multi-Compartment Tray

–Stainless steel construction
–Open and easy access to each of the 6 compartments
–Ideal for buffet, cafeteria, and other self-serving occasions

Item	Description	UOM	Case
STRY-6R	Round Center, 15-1/2" x 11-1/2"	Each	24
STRY-6T	Trapezoid Center, 15-1/2" x 11-1/2"	Each	24



STRY-6T

Plate Cover

–Stainless steel construction
–SPCO-16 fits 10-1/2"Dia plates.
–SPCO-21 and SPCO-1021 fits 12-1/4"Dia plates.

Item	Description	UOM	Case
SPCO-16	11"Dia x 2"H	Doz	1
SPCO-21	12-5/8"Dia x 2"H	Doz	1
SPCO-1021	12-5/8"Dia x 2-3/4"H	Doz	1



SPCO Series

Poly Plate Cover

–Made of durable and heat-resistant polycarbonate
–Ideal to keep food fresh and warm during transporting

Item	Description	Fits	UOM	Case
PPCO-16	10"Dia	9-3/4"Dia Plates	Each	6/36
PPCO-20	11"Dia	10-3/4"Dia Plates	Each	6/36
PPCO-21	12"Dia	11-3/4"Dia Plates	Each	6/36
PPCO-25	14"Dia	13-7/8"Dia Plates	Each	6/36
PPCO-13	12", Oval	11-3/4" x 8-3/4" Oval Plates	Each	6/36
PPCO-41	14", Oval	13-5/8" x 10-1/8" Oval Plates	Each	6/36



PPCO-20



PPCO-13

*Contents not included



TTFB-09 Series



TTFB-10 Series



TWSB-18



TWSB-16



TWSB-14



TWSB-08



SMFB-3



SMFC-3S



SMFC-3H



SMFB-2



SMFB-1



SCKS-13



DCSC-13



Fast Food Basket

- Available in oval and oblong with 5 vibrant colors for ultimate versatility

Item	Description	Color	UOM	Case
TTFB-09BK	9-1/4", Oval	Black	Doz	3
TTFB-09BN	9-1/4", Oval	Brown	Doz	3
TTFB-09GN	9-1/4", Oval	Green	Doz	3
TTFB-09RD	9-1/4", Oval	Red	Doz	3
TTFB-09YL	9-1/4", Oval	Yellow	Doz	3
TTFB-10BK	10-3/4", Oblong	Black	Doz	12
TTFB-10BN	10-3/4", Oblong	Brown	Doz	12
TTFB-10GN	10-3/4", Oblong	Green	Doz	12
TTFB-10RD	10-3/4", Oblong	Red	Doz	12
TTFB-10YL	10-3/4", Oblong	Yellow	Doz	12

Woven Wood Bowl

- Serves salads, side dishes, chips or snacks with a sense of natural charm
 - Made of durable woven wood ideal for high-volume use
 - Stain-, acid-, oil-, and odor-resistant

Item	Description	UOM	Case
TWSB-05	5"	Each	12/288
TWSB-06	6"	Each	12/288
TWSB-08	8"	Each	12/144
TWSB-10	10"	Each	12/96
TWSB-12	12"	Each	12/72
TWSB-14	14"	Each	12/36
TWSB-16	16"	Each	12/24
TWSB-18	18"	Each	12
TWSB-20	20"	Each	12

Mini Fry Cup

- Boasting stainless steel body with smooth or hammered finish, these decorative mini cups bring a sense of delicacy to any food being served inside.
 - Ideal for finger foods, appetizers, and desserts

Item	Description	UOM	Case
SMFC-3S	3-1/2"Dia x 3-1/2"H, Smooth	Each	12/120
SMFC-3H	3-1/2"Dia x 3-1/2"H, Hammered	Each	12/120

Mini Fry Basket

- Durable 304 stainless steel construction

Item	Description	UOM	Case
SMFB-3	4-1/8"L x 3-1/4"W x 3"H	Each	12/72
SMFB-2	5"L x 4-1/8"W x 3-1/4"H	Each	12/72
SMFB-1	3-1/2"Dia x 3-1/2"H	Each	12/72

Cake Stand & Cover

- Minimal assembly required for cake stand

Item	Description	UOM	Case
SCKS-13	13"Dia Cake Stand, S/S	Each	6/12
DCSC-13	Cover for SCKS Series, NSF	Each	6

Mini Serving Pail

- Stainless steel body with an elevated base
- Great alternative to nappies and bowls for serving small portions of food
- Carrying handle for convenient transport
- Available in smooth and hammered finishes

Item	Description	Size	UOM	Case
SMPL-3S	5oz, Smooth	3"Dia x 3-1/8"H	Each	12/72
SMPL-35S	10oz, Smooth	3-1/2"Dia x 3-5/8"H	Each	12/72
SMPL-4S	12oz, Smooth	4"Dia x 3-3/4"H	Each	12/72
SMPL-5S	28oz, Smooth	5"Dia x 5"H	Each	12/48
SMPL-3H	5oz, Hammered	3"Dia x 3-1/8"H	Each	12/72
SMPL-35H	10oz, Hammered	3-1/2"Dia x 3-5/8"H	Each	12/72
SMPL-5H	28oz, Hammered	5"Dia x 5"H	Each	12/48



SMPL-H Series



SMPL-S Series

Tabletop Server

- Stainless steel construction
- Matching lid for every cup protects food inside from dust and splash.
- Versatile design ideal to hold various ingredients, sauces, and food

Item	Description	UOM	Case
STSV-3	3-Compartment	Set	1/24
STSV-4	4-Compartment	Set	1/24
STSV-CUP	Cup for STSV-3/4	Each	12/72
STSV-LID	Lid for STSV-3/4	Each	12/72
STSV-SPN	Spoon for STSV-3/4	Doz	1/144



STSV-3



STSV-4

Bell Shaped Creamer

- Stainless steel

Item	Description	UOM	Case
SSBC-3	3oz	Each	12/144
SSBC-5	5oz	Each	12/144
SSBC-8	8oz	Each	12/144
SSBC-10	10oz	Each	12/72



SSBC-3

SSBC-5

SSBC-8

SSBC-10

Creamer/Server with Lid

- Stainless steel construction with hinged lid

Item	Description	UOM	Case
SSCM-10	10oz	Each	12/120
SSCM-10S	10oz, Stackable	Each	12/120



SSCM-10S



SSCM-10

Sherbet Dish

- Stainless steel

Item	Description	UOM	Case
TTSD-35	3.5oz	Each	12/48
TTSD-50	5oz	Each	12/48



TTSD-35



TTSD-50

Cone Holder

- Glass-like, durable acrylic
- Super versatile countertop holder ideal for cones, cakes, and any cone-shaped desserts and appetizers
- Smooth surface with crystal-clear visibility for an upscaled display
- Easy to clean; hand wash recommended
- BPA free

Item	Description	UOM	Case
ACHS-4	4-Hole	Each	1/12

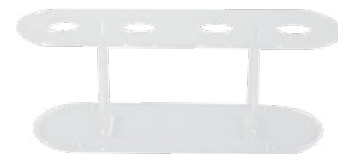

ACHS-4



*Contents not included



SLDB Series

Molcajete Salsa Bowl 🛒

- Made from durable and temperature-resistant plastic for hot and cold serving
- NSF listed; BPA free; stackable



Item	Description	UOM	Case
SLDB-4	4oz, 4-PC/Pack	Pack	1/24
SLDB-10	10oz, 4-PC/Pack	Pack	1/12
SLDB-56	56oz	Each	1/12



TLWM-8

Tortilla Warmer 🛒

- Crafted from food-grade temperature-resistant polypropylene with handled lid
- NSF listed; BPA free; stackable



Item	Description	UOM	Case
TLWM-8	8-1/2" Dia, Brown	Each	1/12



TCHD-23S

TCHD-45S

Taco Holder 🛒

- Stainless steel construction
- Flip upside down to hold different numbers of tacos
- Slot size: 2-3/4" x 2" x 1-3/8"

Item	Description	Size	UOM	Case
TCHD-12S	1 or 2 Compartments	5-1/2" x 4" x 2"	Each	12/96
TCHD-23S	2 or 3 Compartments	8-1/4" x 4" x 2"	Each	12/72
TCHD-34S	3 or 4 Compartments	11-1/2" x 4" x 2"	Each	12/48
TCHD-45S	4 or 5 Compartments	14" x 4" x 2"	Each	12/36



KULC-01

KULC-02



Lobster Cracker

- Durable and rust-resistant metal construction
- Versatile kitchen/dining tool perfect for lobster, oyster, crab, nuts and more
- Cracks shell effortlessly without tearing meat apart
- Easy to clean; dishwasher-safe

Item	Description	UOM	Case
KULC-01	6"L, Chrome Plated	Each	12/144
KULC-02 🛒	6-5/8"L, Heavyweight	Each	12/72



SPPL-2

Syrup Pitcher

- Made of break-resistant SAN plastic
- NSF listed; BPA free



Item	Description	UOM	Case
SPPL-2	2oz, 24-PC/Pack	Pack	6/12



SYDP-32

SYDP-48

Syrup Dispenser

- Durable and lightweight perfect for tabletop service
- Thumb cap with stainless steel lever for easy dispensing and controlled pouring
- Ideal for holding and dispensing syrup, batter, sauce, dressing, olive oil and more
- Color-coded caps are available for purchase separately.

Item	Description	UOM	Case
SYDP-32 🛒	32oz, White Cap	Each	12
SYDP-48 🛒	48oz, White Cap	Each	12
SYCP-3248W	White Cap for SYDP Series	Each	24/144
SYCP-3248R	Red Cap for SYDP Series	Each	24/144
SYCP-3248BG	Beige Cap for SYDP Series	Each	24/144



SYCP-3248W

SYCP-3248R

SYCP-3248BG



Tabletop Glass Shaker

- Convenient spice dispensing with wide selections
- Lead free glass body with stainless steel cap

Item	Description	Capacity	UOM	Case	Replacement Cap		
					Item	UOM	Case
G1SQ-05S	Cube Shaker w/ Cap	0.5oz	Doz	1/48	G1SQ-05S-CP	Doz	24/144
G4PS-1M	Paneled Shaker w/ Mushroom Cap	1oz	Doz	1/10	G4PS-1M-CP	Doz	24/120
G7TK-1S	Tower Shaker w/ Cap	1oz	Doz	1/12	G7TK-1S-CP	Doz	24/144
G6SQ-2M	Square-Base Shaker w/ Mushroom Cap	2oz	Doz	1/12	G6SQ-2M-CP	Doz	12/96
G8CK-2F	Beehive Shaker w/ Flat Cap	2oz	Doz	1/12	G8CK-2F-CP	Doz	24/120
G5CS-6SL	Cheese Shaker w/ Slotted Cap	6oz	Doz	1/5	G5CS-6SL-CP	Doz	5/90
G5CS-6P	Cheese Shaker w/ Perf. Cap	6oz	Doz	1/5	G5CS-6P-CP	Doz	5/90
G2SP-12F	Sugar Pourer w/ Flat Cap	12oz	Doz	1/4	G2SP-12F-CP	Doz	4/48
G2SP-12P	Sugar Pourer w/ Perf. Cap	12oz	Doz	1/4	G2SP-12P-CP	Doz	4/48



Lead Free Glass



Stainless Steel Cap



Oil/Vinegar Cruet

- Lead free glass cruet with stainless steel pourer
- Durable rack with chrome finish
- Ideal for tableside self-serving and presenting
- One set includes 2 oil/vinegar cruets and 1 rack.

Item	Description	Capacity	UOM	Case
W2SQ-6S	Oil/Vinegar Cruet Set	6oz	Set	1/12
W2SQ-8S	Oil/Vinegar Cruet Set	8oz	Set	1/12
W2SQ-16S	Oil/Vinegar Cruet Set	16oz	Set	1/12
G3OC-6	Oil/Vinegar Cruet w/ Pourer	6oz	Doz	1/6
W3SQ-8BT	Oil/Vinegar Cruet w/ Pourer	8oz	Each	12/24
W3SQ-16BT	Oil/Vinegar Cruet w/ Pourer	16oz	Each	12
W4RK-8	Chrome Rack for W3SQ-8BT		Each	6/48
W4RK-16	Chrome Rack for W3SQ-16BT		Each	6/24
G3OC-6-CP	Cap for G3OC-6		Doz	18/108
W3SQ-BT-CP	Pourer Cap for W3SQ-8BT/16BT		Doz	12/48



Ideal for Tableside Self-Serving and Presenting



SDRG-8A



ADRE-10



ADRE-10H



SDRG-22



SDRG-10



SDRG-10H

Adjustable Dredge

- 304 Stainless steel construction
- 3-way adjustable top with small, medium and large holes

Item	Description	UOM	Case
SDRG-8A	8oz, 2-3/4" Dia x 4-1/4"H	Each	12/96

Dredge

Item	Description	UOM	Case
ADRE-10	10oz, w/o Handle, Aluminum	Each	12/144
ADRE-10H	10oz, w/ Handle, Aluminum	Each	12/144
SDRG-10	10oz, w/o Handle, Stainless Steel	Each	12/144
SDRG-10H	10oz, w/ Handle, Stainless Steel	Each	12/144
SDRG-22	22oz, w/o Handle, Stainless Steel	Each	12/48



Squeeze Bottle

- Durable plastic construction with open tip and leak-proof cap
- 6-PC/Pack; BPA free



Item	Description	Color	UOM	Case
SQBT-8C	8oz	Clear	Pack	12
SQBT-8R	8oz	Red	Pack	12
SQBT-8Y	8oz	Yellow	Pack	12
SQBT-12C	12oz	Clear	Pack	12
SQBT-12R	12oz	Red	Pack	12
SQBT-12Y	12oz	Yellow	Pack	12
SQBT-24C	24oz	Clear	Pack	6
SQBT-24R	24oz	Red	Pack	6
SQBT-24Y	24oz	Yellow	Pack	6



SQBT-12C



SQBT-12R



SQBT-12Y



SQBT-W-16C



SQBT-W-16R



SQBT-W-16Y

Wide-Mouth Squeeze Bottle

- Durable plastic construction with open tip and leak-proof cap
- Wide mouth models are easier to refill and clean.
- 6-PC/Pack; BPA free



Item	Description	Color	UOM	Case
SQBT-W-12C	12oz	Clear	Pack	12
SQBT-W-12R	12oz	Red	Pack	12
SQBT-W-12Y	12oz	Yellow	Pack	12
SQBT-W-16C	16oz	Clear	Pack	8
SQBT-W-16R	16oz	Red	Pack	8
SQBT-W-16Y	16oz	Yellow	Pack	8
SQBT-W-24C	24oz	Clear	Pack	8
SQBT-W-24R	24oz	Red	Pack	8
SQBT-W-24Y	24oz	Yellow	Pack	8
SQBT-W-32C	32oz	Clear	Pack	6
SQBT-W-32R	32oz	Red	Pack	6
SQBT-W-32Y	32oz	Yellow	Pack	6

Sauce Cup

- Stainless steel



SSCP-15



SSCP-25



SSCP-40

Item	Description	UOM	Case
SSCP-15	1.5oz	Doz	1/48
SSCP-25	2.5oz	Doz	1/48
SSCP-40	4oz	Doz	1/48

Pepper Mill

- Solid hardwood construction for added durability
- Sleek matte finish for a modern and elegant look
- Ergonomic metal grinding mechanism for easy operation
- Adjustable grinding coarseness with top metal knob

Item	Description	UOM	Case
PMW1-8BN	8"H, Matte Brown	Each	1/36
PMW1-10BN	10"H, Matte Brown	Each	1/24
PMW1-12BN	12"H, Matte Brown	Each	1/24
PMW1-18BN	18"H, Matte Brown	Each	1/12
PMW2-S6BK	6"H Pepper Mill/Salt Shaker 2-PC Set, Matte Black	Set	1/24
PMW2-6K	6"H Pepper Mill 2-PC Set, Matte Black	Set	1/24



BagTec

C.A.C. BagTec Series offers an ideal solution for hot and cold food delivery needs with easy-to-carry design and excellent temperature retention. Available in multiple sizes for different purposes, C.A.C. BagTec Series is designed to carry out busy daily use with long-lasting performance.

Insulated Delivery Bag

- Durable nylon construction with water-resistant exterior
- Reinforced strap with heavy stitches for safe, comfortable carrying and transporting
- Retains more than 95% of the heat within the first 10 minutes and holds temperature above 150°F for 45 minutes.
- Pizza delivery bag is designed with a steam outlet to vent excess moisture.
- Catering delivery bag is designed with a zip closure for convenient opening and secured closing.



Item	Description	Size	UOM	Case
BTCA-1212R	Catering Bag	12" x 12" x 12"	Each	6
BTCA-1222R	Catering Bag	22" x 22" x 12"	Each	6
BTPZ-0518R	Pizza Bag	18" x 18" x 5"	Each	6
BTPZ-0520R	Pizza Bag	20" x 20" x 5"	Each	6
BTPZ-0524R	Pizza Bag	24" x 24" x 5"	Each	6



Countertop Protective Shield

Made of quality acrylic with high-tensile strength, C.A.C. Countertop Protective Shield Series offers great barrier protection with glass-like visibility and lasting durability. Every free-standing shield is portable and requires no mounting for maximized convenience, making this series an ideal solution to help prevent transmission of airborne particulate between employees and customers.

- Durable, scratch-resistant and transparent acrylic construction
- Free-standing and stable

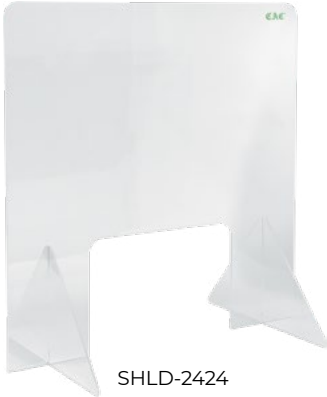

SHLD-2424

Self-Standing Protective Shield with Window

- Pass-through window for convenient transactions
- Extra thickness of 1/4" in SHLD-3041 and SHLD-4832
- BPA free



Item	Description	UOM	Case
SHLD-2424	24"W x 24"H	Set	1
SHLD-2432	24"W x 32"H	Set	1
SHLD-3632	36"W x 32"H	Set	1
SHLD-3041	30"W x 41"H	Set	1
SHLD-4832	48"W x 32"H	Set	1



SHLD-2432



SHLD-4832

Self-Standing Protective Shield

- Extra thickness of 1/4" in SHLD-4832N
- BPA free



Item	Description	UOM	Case
SHLD-2432N	24"W x 32"H	Set	1
SHLD-3632N	36"W x 32"H	Set	1
SHLD-4832N	48"W x 32"H	Set	1



SHLD-2432N



SHLD-4832N

Crowd-Control Stanchion & Sign System

C.A.C. Crowd-Control Stanchion & Sign System aids in directing and organizing waiting lines with 4-way head for flexible guiding patterns and weighted base for sturdy holding. This series provides an easy yet professional solution whether in guiding visitor flow or cordoning off restricted areas with discreet appearance and great performance.

Stanchion Stand

- 36" stanchion post with weighted base and 6-1/2 feet retractable belt
- 4-way head provides flexible directioning.
- CCSC-36K and CCSC-36S are sold by case.

Item	Description	UOM	Case
CCSC-36K	36", Metal Black	Each	2
CCSC-36S	36", Stainless Steel	Each	2
CCSW-36BR	Wall Bracket for CCSC Series	Each	100
CCSH-36BLT	Belt Head for CCSC Series	Each	12/48



CCSC-36K



CCSC-36S

Stanchion Frame

- Available in black and silver to match CCSC Series stanchion stands
- Fits CCSN pre-printed signs
- Fits letter size 11" x 8-1/2" inserts

Item	Description	UOM	Case
CCSF-1K	Black	Each	1/4
CCSF-1S	Silver	Each	1/4



CCSF-1K



CCSF-1S

Stanchion Sign

- Double-sided, white-on-black design ensures clear and maximized visibility.
- Pre-printed with various contents for different purposes and occasions

Item	Description	UOM	Case
CCSN-ET1	PLEASE ENTER HERE	Each	6/36
CCSN-WT2	PLEASE WAIT TO BE SEATED	Each	6/36
CCSN-LN3	LINE FORMS HERE	Each	6/36
CCSN-CS4	SORRY SECTION CLOSED	Each	6/36
CCSN-EX5	EXIT	Each	6/36
CCSN-DT6	PRACTICE SOCIAL DISTANCING	Each	6/36
CCSN-CL7	AREA CLOSED	Each	6/36

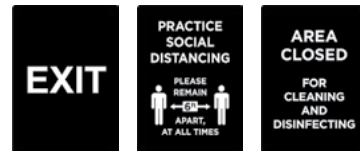

CCSN Series

Stanchion Sign Set

- Each set includes two 36" stanchion stands, one black sign frame, and one double-sided pre-printed sign.
- Accessories, replacement parts, and more options of pre-printed signs are available and sold separately.

Item	Description	UOM	Case
CCSN-SET6	PRACTICE SOCIAL DISTANCING	Set	1



CCSN-SET6

Compliance Symbol Sign

C.A.C. Compliance Symbol Sign Series is made of durable plastic. These signs are light in weight and easy to maintain and clean. Designed with self-adhesive backing, they can easily stick to walls, doors, above the sink, or wherever is desired, to suit various needs of a commercial setting.

- Universally recognized symbols
- Clear instruction in words and visual symbol
- Easy to read with clear color contrast between content and background
- Durable heavy-duty plastic construction
- Pressure-sensitive self-adhesive tape



SCS3-EE01

SCS3-NM06



SCS3-HW02

SCS3-RR07



SCS3-WS03

SCS3-WH08



SCS3-RS04

SCS3-MN09



SCS3-SZ05

SCS3-WO10

9" x 3" English Sign

Item	Description	Color	UOM	Case
SCE3-PS01	Push	Black	Each	12/144
SCE3-PL02	Pull	Black	Each	12/144
SCE3-PV03	Private	Black	Each	12/144
SCE3-RV04	Reserved	Black	Each	12/144
SCE3-EE05	Employees Only	Black	Each	12/144
SCE3-HW06	Hand Wash Only	Black	Each	12/144
SCE3-WS07	Wash	Black	Each	12/144
SCE3-RS08	Rinse	Black	Each	12/144
SCE3-SZ09	Sanitize	Black	Each	12/144
SCE3-CG10	Cell Phone Charging Station	Black	Each	12/144
SCE3-WF11	WiFi	Black	Each	12/144
SCE3-NA12	No Admittance	Black	Each	12/144
SCE3-NP13	No Pets. Shoes and Shirt Required	Black	Each	12/144
SCE3-NF14	No Food or Drink	Black	Each	12/144
SCE3-NC15	No Cell Phone Use, Please	Black	Each	12/144
SCE3-NS16	No Soliciting	Black	Each	12/144
SCE3-NM17	No Smoking	Black	Each	12/144
SCE3-NV18	No Smoking or Vaping	Black	Each	12/144
SCE3-NE19	Not an Exit	White	Each	12/144
SCE3-EX20	Exit	White	Each	12/144
SCE3-FE21	Fire Extinguisher	White	Each	12/144
SCE3-CT22	Caution Watch Your Step	Black	Each	12/144
SCE3-WH23	Employees Must Wash Hands Before Returning To Work	Black	Each	12/144
SCE3-RM24	Restrooms	Black	Each	12/144
SCE3-RC25	Restrooms for Customer Use Only	Black	Each	12/144
SCE3-MN26	Men	Black	Each	12/144
SCE3-WO27	Women	Black	Each	12/144

9" x 3" Bilingual English/Spanish Sign

Item	Description	Color	UOM	Case
SCS3-EE01	Spanish, Employees Only	Black	Each	12/144
SCS3-HW02	Spanish, Hand Wash Only	Black	Each	12/144
SCS3-WS03	Spanish/English, Wash	Black	Each	12/144
SCS3-RS04	Spanish/English, Rinse	Black	Each	12/144
SCS3-SZ05	Spanish/English, Sanitize	Black	Each	12/144
SCS3-NM06	Spanish/English, No Smoking	Black	Each	12/144
SCS3-RR07	Spanish/English, Restrooms	Black	Each	12/144
SCS3-WH08	Spanish, Employees Must Wash Hands Before Returning to Work	Black	Each	12/144
SCS3-MN09	Spanish/English, Men	Black	Each	12/144
SCS3-WO10	Spanish/English, Women	Black	Each	12/144

6" x 9" English Sign 🛒

Item	Description	Color	UOM	Case
SCE9-NM01	No Smoking	Black	Each	12/72
SCE9-EX02	Exit	White	Each	12/72
SCE9-FE03	Fire Extinguisher	White	Each	12/72
SCE9-SW04	In Case of Fire Do Not Use Elevator Use Stairwell	White	Each	12/72
SCE9-NM05	No Smoking Area	White	Each	12/72
SCE9-AC06	Wheelchair Accessible	Blue	Each	12/72
SCE9-RR07	Restrooms	Black	Each	12/72
SCE9-MN08	Men	Blue	Each	12/72
SCE9-WO09	Women	Blue	Each	12/72



English Sign
SCE9 Series

LED Sign

C.A.C. LED Display Sign Series is eye-catching and energy-efficient, and will help you outshine your competitors right out of the box.

LED Sign 🛒

- Attractive and ultra bright display sign with energy-saving LEDs
- Great visibility in daylight and behind the window
- Lightweight and easy to operate with AC/DC adapter and hanging chain included
- Acrylic dust-proof cover for easy maintenance and added durability
- UL listed AC/DC adapter
- 3-year warranty



Item	Description	Size	UOM	Case
SLED-OP01	OPEN, Rectangular	22"L x 1-1/2"W x 13"H	Each	1/5
SLED-OP02	OPEN, Oval, 3 Modes	22-3/4"L x 1-3/4"W x 14"H	Each	1/5
SLED-PZ03	PIZZA, Oval, 3 Modes	22-3/4"L x 1-3/4"W x 14"H	Each	1/5



SLED-OP01



SLED-OP02



SLED-PZ03



Hanging Kit



Pull String

Airpot

Constructed with double-wall insulated body and stainless steel or glass liner, C.A.C. Airpot Series offers a reliable solution for keeping drinks at constant temperature for an extended period of time. The professional appearance and beneficial key features make C.A.C. Airpot Series an excellent choice for self-service counters, restaurants, catering services, diners, coffee shops and more.



APSL Lever Top Series APSL Push Button Series

Stainless Steel Lined Airpot 🛒

- Double-wall vacuum insulated for extended 12-hour heat retention
- Stainless steel liner and exterior for protection against damage
- Carrying handle allows for easy transporting.
- 360 degree swivel base for easy access
- Ideal to hold wide variety of hot or cold beverages for optimized versatility
- Professional appearance fits various occasions.

Item	Description	UOM	Case
APSL-25PB	2.5L, Push Button	Each	1/6
APSL-30PB	3.0L, Push Button	Each	1/6
APSL-25LT	2.5L, Lever Top	Each	1/6
APSL-30LT	3.0L, Lever Top	Each	1/6



APGL Lever Top Series APGL Push Button Series

Glass Lined Airpot 🛒

- Double-wall vacuum insulated for extended 12-hour heat retention
- Carrying handle allows for easy transporting.
- 360 degree swivel base for easy access
- Ideal to hold wide variety of hot or cold beverages for optimized versatility
- Professional appearance fits various occasions.

Item	Description	UOM	Case
APGL-22PB	2.2L, Push Button	Each	1/6
APGL-25PB	2.5L, Push Button	Each	1/6
APGL-19LT	1.9L, Lever Top	Each	1/6
APGL-22LT	2.2L, Lever Top	Each	1/6
APGL-25LT	2.5L, Lever Top	Each	1/6



APLT-LID

APPB-LID

Replacement Lid

- Available in push button and lever top

Item	Description	UOM	Case
APLT-LID	Lever Top Lid	Each	48
APPB-LID	Push Button Lid	Each	48



DTAP-RS

Drip Tray

Item	Description	UOM	Case
DTAP-RS	Airpot Drip Tray	Each	24



FCPS-33

Coffee Press

French Press 🛒

- 304 stainless steel plug and filter for durability
- Borosilicate glass body for superior resilience to thermal shock
- Soft touch handle for comfortable grip

Item	Description	UOM	Case
FCPS-33	33oz/1000ML	Each	1/12

Electric Urn Coffee Maker

C.A.C. Urn Coffee Maker Series is ideal for fast brewing and high volume coffee dispensing. Constructed with quality stainless steel urn body, this series is an excellent addition for restaurants, catering services, buffets and other large venues.

Deluxe Urn Coffee Maker

- Durable 304 stainless steel percolator pipe and filter basket
- Double-walled stainless steel body; cool-touch handles and locking lid
- Non-drip one-hand dispensing tap
- Interior and exterior water level marks for guidance
- Auto shifts to keep warm and holds at serving temperature
- Built-in heater temperature control; boil-dry prevention control
- Fast brewing with no additional filter required
- ETL listed; meets and complies with electrical safety standards in the U.S.A. (UL-197) and Canada (CAN/CSA-C22.2)
- One-year warranty



BVCM-110

Item	Description	UOM	Case
BVCM-110	108 Cups*/16L	Each	1/2
BVCM-110TP	Tap for BVCM-110	Each	50



Cool-Touch Handle and Locking Lid



Water Level Marks

Urn Coffee Maker

- Durable 304 stainless steel body and percolator pipe
- Cool-touch handles, double-layer lid and non-skid rubber feet
- Non-drip one-hand dispensing tap
- Interior water level marks for guidance
- Built-in heater temperature control; boil-dry prevention control
- Fast brewing with no additional filter required
- ETL listed; meets and complies with electrical safety standards in the U.S.A. (UL-197) and Canada (CAN/CSA-C22.2)
- One-year warranty



BVCM-40

Item	Description	UOM	Case
BVCM-30	30 Cups*/4.5L	Each	1/2
BVCM-40	40 Cups*/6L	Each	1/2
BVCM-340TP	Tap for BVCM-30/40	Each	50

SPECIFICATIONS

	BVCM-110	BVCM-40	BVCM-30
Capacity	108 Cups/16L	40 Cups/6L	30 Cups/4.5L
Color	Silver/Black	Silver/Black	Silver/Black
Dimensions	10-5/8" Dia x 20-1/4"H	7-1/2" Dia x 16-1/2"H	7-1/2" Dia x 14-3/8"H
Voltage	110-120V	110-120V	110-120V
Power	1500W	950W	950W
Frequency	60Hz	60Hz	60Hz
Plug Type	5-15P	5-15P	5-15P
Cord Length	5ft.	3-1/2ft.	3-1/2ft.
Shipping Dimensions	13-3/8" x 13-3/8" x 22-1/4"H	8-7/8" x 8-7/8" x 17-3/8"H	8-7/8" x 8-7/8" x 15-1/8"H
Shipping Weight	12.7lbs	5.1lbs	4.6lbs

* Based on 5-oz cup



BVDW-20

SSCF Series

Stainless Steel Lined Carafe

- 12-hour heat retention
- Double-wall insulated
- Drip-free thumb lever lid

Item	Description	UOM	Case
SSCF-12	1.2L	Each	1/8
SSCF-15	1.5L	Each	1/8
SSCF-21	2.1L	Each	1/8
SSCF-LID	Replacement Lid	Each	200

Stainless Steel Coffee Server

- Double-wall insulation
- Elevated base
- Satin finish

Item	Description	UOM	Case
BVDW-20	20oz	Each	1/12



BVCS Series

Stainless Steel Creamer

- Vacuum insulated stainless steel body
- Elevated base
- One-hand dispensing

Item	Description	UOM	Case
BVCS-24	24oz	Each	1/12
BVCS-33	33oz	Each	1/12



BVSR Series

Swirl Beverage Server

- Impact-resistant plastic construction
- Double-wall insulation with durable and temperature-resistant liner
- One-hand dispensing with thumb lever
- NSF listed



Item	Description	Color	UOM	Case
BVSR-20W	20oz	White	Each	1/24
BVSR-20BK	20oz	Black	Each	1/24
BVSR-42W	42oz	White	Each	1/12
BVSR-42BK	42oz	Black	Each	1/12
BVSR-64W	64oz	White	Each	1/6
BVSR-64BK	64oz	Black	Each	1/6



BVCD-64K

BVCD-64OR

Coffee Decanter

- Clear polycarbonate body with stainless steel base for added strength and durability
- Ergonomic spout and handle for effortless serving and transporting

Item	Description	UOM	Case
BVCD-64K	64oz, Black	Each	1/24
BVCD-64OR	64oz, Orange	Each	1/24



GLTP-25

Glass Teapot

- Durable glass construction with half plastic frame
- Removable 304 stainless steel infuser

Item	Description	UOM	Case
GLTP-25	25oz, Black	Each	1/48

Gooseneck Teapot

- Durable stainless steel construction with mirror finish and a classic look
- Gooseneck spout for easy and precise serving
- Hinged lid with venting hole; cool-touch handle for safe serving and transporting

Item	Description	UOM	Case
BVTP-20	20oz	Each	1/24
BVTP-32	32oz	Each	1/24



BVTP Series

Frothing Pitcher

- Made of 18/8 stainless steel for optimal rust- and corrosion-resistance

Item	Description	UOM	Case
BVFP-12	12oz	Each	1/48
BVFP-20	20oz	Each	1/48
BVFP-32	32oz	Each	1/36
BVFP-48	48oz	Each	1/24
BVFP-70	70oz	Each	1/24



BVFP-32



BVFP-70

Coffee Knock Box

- Convenient barista tool that collects espresso grounds and fits any standard GN 1/6 openings
- 23 gauge stainless steel construction with cushioning knock bar
- Crimped edge design for easy transporting and recessing into counters

Item	Description	UOM	Case
SCKB-765	5" Deep	Each	1/24



SCKB-765



Cushioning Knock Bar

Cup/Lid Organizer

- Durable acrylic construction with easy access to all compartments
- Compact organizing station holds cups and lids up to 4" in diameter.
- Versatile for cups, lids, and condiments such as drink stirrers, straws, sugar packets, creamers and more
- Easy to clean; hand wash recommended
- BPA free



Item	Description	UOM	Case
ACO2-2A	2-Tier, 2-Stack	Each	1/4
ACO2-3B	2-Tier, 3-Stack	Each	1/4
ACO3-2C	3-Tier, 2-Stack	Each	1/4
ACO3-3D	3-Tier, 3-Stack	Each	1/4



ACO3-3D

*Contents not included



ACO2-2A



ACO2-3B



ACO3-2C



FSBV-6



Front & Back Views

Beverage Dispenser/Container

- Impact-resistant polypropylene withstands temperatures from -40°F/-40°C to 160°F/71°C.
- Capacity of 22.7L/6 gallon with red graduations in both QT and Liter, ideal for mixing, deconcentrating, and dispensing beverages
- Secure-fit lid, carrying handle and anti-drip press faucet are included in FSBV-6.
- Replacement faucet FSBV-FT is available for purchase separately.
- BPA free; dishwasher safe



Item	Description	UOM	Case
FSBV-6	22.7L/6 Gallon	Set	1/4
FSBV-FT	Press Faucet for FSBV-6	Each	50



Anti-Drip Press Faucet

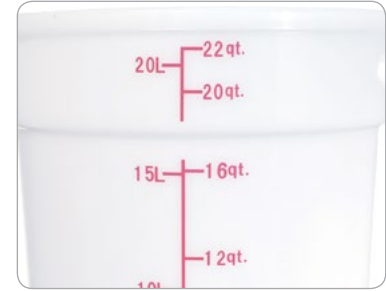

Graduations in QT and Liter



SWBT-5

SWBT-ST



SWBT-8

SWBT-8FX

Wine Bucket and Stand

- Sturdy stainless steel construction with mirror finish perfect for tableside services
- Knob-handled and hanging-handle bucket for added portability
- Elegant, stable tri-leg stand (foldable or fixed) adds a charm to any drink occasions.

Item	Description	UOM	Case
SWBT-5	Bucket w/ Hanging Handle, 8-3/8"Dia x 8"H	Each	6/24
SWBT-8	Bucket w/ Knob Handle, 8QT	Each	6/24
SWBT-ST	Stand for SWBT-5, 28-1/2"H	Each	1/6
SWBT-8FD	Foldable Stand for SWBT-8, 28-1/8"H	Each	1/6
SWBT-8FX	Fixed Stand for SWBT-8, 28-1/8"H	Each	1/12

Wine Cooler

- Compact double-walled stainless steel wine cooler that keeps drinks inside chill for hours.
- Great temperature retention inside and minimized condensation outside
- No ice or pre-chilling needed

Item	Description	UOM	Case
SWCS-8	Straight, 4-1/2"Dia x 7-7/8"H	Each	6/24



SWCS-8



TBSI-87

Galvanized Pail

- Made of rust-resistant galvanized metal
- Hanging handle for easy transporting
- Versatile and great for self-serve applications such as serving iced drinks at parties

Item	Description	UOM	Case
TBSI-87	8"Dia x 7"H	Each	12

Slim Iced Tea Dispenser

- 304 stainless steel body and valve for corrosion-resistance and durability
- Slim shape with welded front handle and built-in back handle for space saving and convenient transporting
- Anti-drip dispensing faucet and detachable drip tray help keep a clean countertop.
- Ideal for beverage stations at restaurants, coffee shops, buffets, meetings and more
- Each set includes 3 pre-printed labels (ICED COFFEE, ICED TEA and LEMONADE) and 1 blank label.

Item	Description	UOM	Case
BVDS-IT3	3 Gallon	Set	1
BVDS-IT5	5 Gallon	Set	1



Detachable Drip Tray



Built-In Back Handle



BVDS-IT5

BVDS-IT3

Beverage Dispenser

- Mirror finish lid and stand with clear polycarbonate container add a sleek and elegant touch.
- Break-resistant container with corrosion-resistant ice core for long-lasting performance
- Center ice core when filled with ice keeps beverage cold for hours without watering down the beverage.
- Ideal for holding and dispensing lemonade, tea, juice, sangria, water and more
- Removable drip tray, lid, ice core, and container for easy refills and cleaning
- Replacement faucet and container are available for purchase separately.

Item	Description	UOM	Case
BVDS-J2S	2.2 Gallon, Silver SS/PC	Set	1
BVDS-J2G	2.2 Gallon, Silver/Gold SS/PC	Set	1
BVDS-J2FT	Faucet for BVDS-J2 Series	Each	12/48
BVDS-J2CTN	Clear Container for BVDS-J2 Series	Each	4



BVDS-J2G

BVDS-J2S



BVDS-J2FT



BVDS-J2CTN

Ice Bucket

- Large capacity holds more ice for convenient serving.
- Durable, corrosion-resistant, and double-walled stainless steel construction
- Great temperature retention inside and minimized condensation outside
- Carrying handle for easy transporting and maximized portability
- Metal finish with an elegant and professional look

Item	Description	UOM	Case
ICBS-66	Double-Wall w/ Lid, 66oz	Each	1/8



ICBS-66



SWPT-64G



SWPT-64L



SWPH-2



SWPH-3



SWPH-2G



SWPH-3G



SWPB-3



SWPB-3G



DCTL Series

Water/Beverage Pitcher

- Stainless steel construction
- Large capacity with ice guard for easy serving

Item	Description	UOM	Case
SWPT-64G	2QT/64oz, w/ Ice Guard	Each	1/12

Coffee Server

- Stainless steel construction
- Hinged lid stays attached when refilling for added convenience.

Item	Description	UOM	Case
SWPT-64L	2QT/64oz w/ Hinged Lid	Each	1/12

Hammered Bell Shaped Water Pitcher

- Made of durable stainless steel
- Classic bell shape with hammered finish adds a sense of charm while serving.

Item	Description	UOM	Case
SWPH-2	2QT/64oz, w/o Ice Guard	Each	1/24
SWPH-2G	2QT/64oz, w/ Ice Guard	Each	1/24
SWPH-3	3QT/96oz, w/o Ice Guard	Each	1/24
SWPH-3G	3QT/96oz, w/ Ice Guard	Each	1/24

Bell Shaped Water Pitcher

- Stainless steel

Item	Description	UOM	Case
SWPB-2	2QT/64oz, w/o Ice Guard	Each	1/12
SWPB-2G	2QT/64oz, w/ Ice Guard	Each	1/12
SWPB-3	3QT/96oz, w/o Ice Guard	Each	1/12
SWPB-3G	3QT/96oz, w/ Ice Guard	Each	1/12

Decanter with Lid

- Clear polycarbonate body
- NSF listed



Item	Description	Color	UOM	Case
DCTL-05	0.5QT/16oz	Clear	Each	24
DCTL-10	1QT/32oz	Clear	Each	24
DCTL-16	1.6QT/51.2oz	Clear	Each	24

Water Pitcher and Beer Pitcher

- Durable polycarbonate body ideal for high volume establishments
- 3-spout models designed for convenient serving, easy access and added versatility
- NSF listed



Item	Description	UOM	Case
WPBV-32C	1QT/32oz, 1-Spout, Clear	Each	12
WPBV-48C	1.5QT/48oz, 1-Spout, Clear	Each	12
WPBV-60C	1.9QT/60oz, 1-Spout, Clear	Each	12
WP3S-60C	1.9QT/60oz, 3-Spout, Clear	Each	12
WP3S-60A	1.9QT/60oz, 3-Spout, Amber	Each	12
WPBR-61C	1.9QT/60oz, Beer, Clear	Each	12



WPBV-32C



WP3S-60A



WPBR-61C

Tumbler with Pebbled Texture

- Constructed with break-resistant quality SAN plastic
- Pebbled texture helps guard against visible scratch and water stain.
- Bottom lugs designed to promote air circulation for fast drying
- BPA free; stackable; dishwasher safe



Item	Description	Color	UOM	Case
BVPT-05AM	5oz	Amber	Doz	6
BVPT-05BL	5oz	Blue	Doz	6
BVPT-05CL	5oz	Clear	Doz	6
BVPT-05RD	5oz	Red	Doz	6
BVPT-08AM	8oz	Amber	Doz	6
BVPT-08BL	8oz	Blue	Doz	6
BVPT-08CL	8oz	Clear	Doz	6
BVPT-08RD	8oz	Red	Doz	6
BVPT-10AM	10oz	Amber	Doz	6
BVPT-10BL	10oz	Blue	Doz	6
BVPT-10CL	10oz	Clear	Doz	6
BVPT-10RD	10oz	Red	Doz	6
BVPT-12AM	12oz	Amber	Doz	6
BVPT-12BL	12oz	Blue	Doz	6
BVPT-12CL	12oz	Clear	Doz	6
BVPT-12RD	12oz	Red	Doz	6
BVPT-16AM	16oz	Amber	Doz	6
BVPT-16BL	16oz	Blue	Doz	6
BVPT-16CL	16oz	Clear	Doz	6
BVPT-16RD	16oz	Red	Doz	6
BVPT-20AM	20oz	Amber	Doz	2
BVPT-20BL	20oz	Blue	Doz	2
BVPT-20CL	20oz	Clear	Doz	2
BVPT-20RD	20oz	Red	Doz	2
BVPT-24AM	24oz	Amber	Doz	2
BVPT-24BL	24oz	Blue	Doz	2
BVPT-24CL	24oz	Clear	Doz	2
BVPT-24RD	24oz	Red	Doz	2
BVPT-32AM	32oz	Amber	Doz	2
BVPT-32BL	32oz	Blue	Doz	2
BVPT-32CL	32oz	Clear	Doz	2
BVPT-32RD	32oz	Red	Doz	2



BVPT Series



Pebbled Texture



SSRH-22S



SSRH-22D

Speed Rail Bottle Holder

- Heavy-duty stainless steel bar organizer perfect for holding and displaying liquors, squeeze bottles, pour bottles and other bar supplies
- Easy to install with integrated keyhole and hanger kit (sold separately)

Item	Description	UOM	Case
SSRH-22S	22", 1-Tier	Each	1/6
SSRH-32S	32", 1-Tier	Each	1/6
SSRH-42S	42", 1-Tier	Each	1/6
SSRH-22D	22", 2-Tier	Each	1/6
SSRH-32D	32", 2-Tier	Each	1/3
SSRH-42D	42", 2-Tier	Each	1/3
SSRH-HNG	Hanger Kit for SSRH series (Not Shown)	Set	12/120



KUHW-4

Hawthorne Strainer

- Perforated, stainless steel construction, great for filtering ice and solids from drinks
- Heavy-duty coiled spring helps fit the strainer well with shakers and mixing glasses.
- 4-prong design with a finger stop enables added balance and secure grasp for non-messy pouring.

Item	Description	UOM	Case
KUHW-4	4-Prong	Each	12/288



KUJP-6

Julep Strainer

- Bowl-shape, perforated surface for quick draining
- Corrosion-resistant stainless steel body for lasting use

Item	Description	UOM	Case
KUJP-6	6-1/4"L	Each	12/240



KUST-6

Juice Strainer

- Rust-, tarish-, corrosion-, and acid-resistant stainless steel construction
- Ideal for squeezing lemon and lime
- Easy to use with seed-free straining

Item	Description	UOM	Case
KUST-6	6"Dia	Each	12/144



CKSW-4S



BRSP-11R

Bar Spoon

- Handy stainless steel bar helper with twisted handle for firm grip when stirring in tall glass
- Weighted teardrop-shaped end adds balance when in use.

Item	Description	UOM	Case
BRSP-11R	11"	Each	24/600

Wing-Style Corkscrew

- Double wings with sharp point for effortless cork extraction and foil cutting

Item	Description	UOM	Case
CKSW-4S	Chrome-Plated	Each	12/144



CKSW-1



CKSW-2



CKSW-3

Waiter's Corkscrew

- Easy-to-carry pocket size
- Versatile wine accessory with cutting, inserting, turning and opening all-in-one

Item	Description	UOM	Case
CKSW-3	Black Finish	Each	12/144
CKSW-2	S/S w/ Curved Handle	Each	12/144
CKSW-1	Hinged Double Lever	Each	6/96

Jigger

- Dual-sided measuring design with clear marking on each side for consistent proportion results
- Rolled edge for easy liquid pouring
- Made of durable and corrosion-resistant stainless steel

Classic Style Jigger

Item	Description	UOM	Case
JG50-100	0.5oz/1oz	Each	12/300
JG75-125	0.75oz/1.25oz	Each	12/300
JG75-150	0.75oz/1.5oz	Each	12/300
JG10-150	1oz/1.5oz	Each	12/300
JG10-200	1oz/2oz	Each	12/300



Japanese Style Jigger

- Extended tall shape allows for smooth pours and minimum spills.

Item	Description	UOM	Case
JGS1-0575	0.5oz/0.75oz	Each	12/300
JGS1-0510	0.5oz/1oz	Each	12/300
JGS1-1125	1oz/1.25oz	Each	12/300
JGS1-1020	1oz/2oz	Each	12/300



Cobbler Cocktail Shaker

- 3-piece set with built-in strainer that keeps drink cold while shaking.
- Top cap seals the shaker tightly to avoid leaking during use.
- Strainer keeps ice inside while pouring the drink out.

Super Cobbler Shaker

- Deluxe stainless steel construction

Item	Description	UOM	Case
SCSK-20S	20oz, Deluxe	Each	1/24
SCSK-28S	28oz, Deluxe	Each	1/12



Cobbler Shaker

Item	Description	UOM	Case
SCSK-10	10oz	Each	12/48
SCSK-16	16oz	Each	1/24
SCSK-28	28oz	Each	1/24

Bar Shaker Cup

- Stainless steel construction with weighted base stands up to intensive use.
- 15oz- and 30oz-cups can be used together to mix drinks.

Item	Description	UOM	Case
BSKS-15	15oz	Each	12/144
BSKS-30	30oz	Each	12/72

Malt Cup

- Stainless steel body fits well with standard spindle drink mixer and milkshake machine.
- Ergonomic, indented side for sturdy operation

Item	Description	UOM	Case
CPMT-30S	30oz	Each	6/72





CDHL-4



CDHL-6



GLRM-3



Condiment Holder

- Durable and impact-resistant ABS plastic construction
- Ice-fillable base to help keep food fresh
- Convenient pack includes base, lid and removable food-grade inserts.
- NSF listed; BPA free



Item	Description	UOM	Case
CDHL-4	4-Compartment	Each	1/6
CDHL-6	6-Compartment	Each	1/6
CDHL-4IN	1QT Insert for CDHL-4, 4-PC/Pack	Pack	24
CDHL-6IN	1PT Insert for CDHL-6, 6-PC/Pack	Pack	24

3-Tier Glass Rimmer

- Durable and impact-resistant ABS plastic construction
- 3 rotating compartments for functionality and compact storage
- 1 sponge included in the Lime Juice section
- NSF listed; BPA free



Item	Description	UOM	Case
GLRM-3	3-Tier with Sponge	Each	1/12
GLRM-SPG	Sponge for GLRM-3	Each	12/144



BCDY-6

Bar Caddy

- Compact and lightweight organizer with easy access to all 6 compartments
- NSF listed; BPA free



Item	Description	UOM	Case
BCDY-6	6-Compartment	Each	12

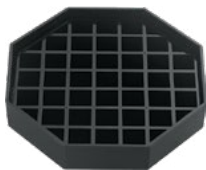

DTBV Series



Drip Tray

- Durable plastic withstands hot or cold liquid drip.
- Removable grid for easy cleaning; level surface for stable holding of drinkware
- Ideal to trap drip and help avoid liquid overflow
- NSF listed, BPA free



Item	Description	UOM	Case
DTBV-4	4-1/2" Dia, 4-PC/Pack	Pack	12/24
DTBV-6	6" Dia, 4-PC/Pack	Pack	12/24

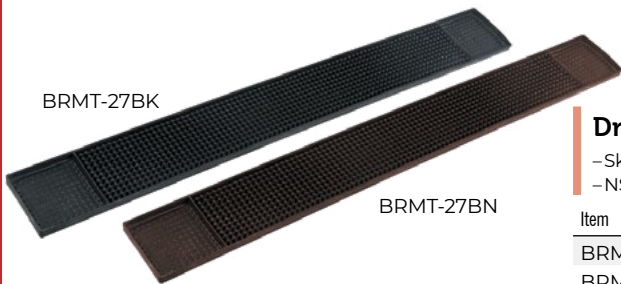

BRMT-27BK

BRMT-27BN

Drink Rail Mat

- Skid-resistant surface with round nubs and receptacle ends
- NSF listed; BPA free



Item	Description	Color	UOM	Case
BRMT-27BN	27" x 3-1/4"	Brown	Each	12/48
BRMT-27BK	27" x 3-1/4"	Black	Each	12/48

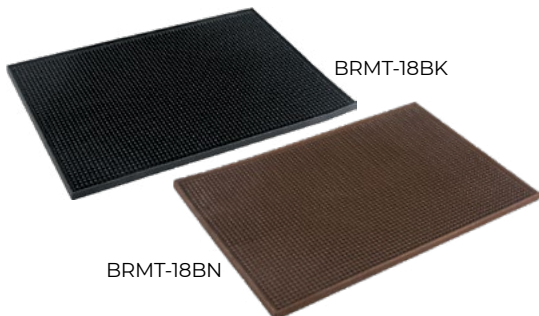

BRMT-18BK

BRMT-18BN

Service Mat

- Excellent drainage with bristled surface for improved sanitation and fast drying
- NSF listed; BPA free



Item	Description	Color	UOM	Case
BRMT-18BN	18" x 12"	Brown	Each	12
BRMT-18BK	18" x 12"	Black	Each	12

Citrus Squeezer

- Durable aluminum body with acid-resistant finish
- Fast and easy use; no pulp and seed; does not absorb odor and easy to clean

Item	Description	Color	UOM	Case
KULS-1G	2-1/2" Dia	Green	Each	6/48
KULS-2Y	3" Dia	Yellow	Each	6/48
KULS-3OR	3-1/2" Dia	Orange	Each	9/36
KULS-21YG	3" Dia, 2-in-1	Yellow/Green	Each	6/24



KULS-21YG



KULS-1G



KULS-2Y



KULS-3OR

Reusable Straw

- Made of durable and rust-resistant 18/8 stainless steel
- Reusable and eco-friendly sip straw for drinks and cocktails
- Straw dimension 1/4" Dia x 8-1/2" L, ideal size for highball glasses, mixing glasses, longdrink glasses, collins glasses and more
- 5-PC pack includes 4 straws and 1 cleaning brush
- Dishwasher safe

Item	Description	UOM	Case
STRA-8S	Straight, 5-PC/Pack	Pack	12/48
STRA-8B	Bend, 5-PC/Pack	Pack	12/48



STRA-8S



STRA-8B

Moscow Mule Mug with Copper Plating

- Boasting a classic copper-plated exterior with smooth or hammered finish, these versatile mugs serve ice-cold beverage with a sense of quaint charm.

Item	Description	UOM	Case
SCMM-20	20oz, Smooth Finish	Each	1/36
SCMM-20H	20oz, Hammered Finish	Each	1/36



SCMM-20



SCMM-20H

Tropical Tumbler

- Made of high-quality clear plastic with blue tint
- NSF listed; BPA free; stackable; dishwasher safe



Item	Description	Color	UOM	Case
TMLH-9	9oz	Blue/Clear	Doz	6
TMLH-12	12oz	Blue/Clear	Doz	6
TMLH-16	16oz	Blue/Clear	Doz	4



TMLH Series

Ashtray

- Available in stainless steel and porcelain
- AST-3 and AST-4: sold by case

Item	Description	UOM	Case
SAST-4	4" Dia Stainless Steel	Each	24/96
AST-3	3" Dia Porcelain	Doz	4
AST-4	4" Dia Porcelain	Doz	4



AST-4



SAST-4

Plastic Ashtray

- 1-3/4" deep well with 8 side-notches in break- and heat-resistant melamine
- Stackable; BPA free; dishwasher safe



Item	Description	Color	UOM	Case
PAST-4K	4" Dia	Black	Doz	1/12
PAST-4R	4" Dia	Red	Doz	1/12



PAST-4R



PAST-4K



Compact Sound Enclosure



MXBD-1500

BlendKing Commercial Blender

BlendKing® Blender Series is designed to meet commercial standard and can crush and blend large volume of ice cubes, frozen fruits, or any mixtures with high efficiency, making this series an essential helper for bars and commercial kitchens.

3.75HP High Power Blender

- Compact sound enclosure reduces decibel exposure during use.
- Removable center lid plug allows easy and continuous ingredient add-ins with included tamper.
- 51oz durable and temperature-resistant BPA-free food grade jug handles large volume of ingredients.
- Industrial grade corrosion-resistant stainless steel blade evenly powers through ice and tough ingredients in seconds.
- 2-in-1 agitator assembly works well with both wet and dry ingredients.
- User-friendly control panel cuts down on operation time.
- Adjustable speed up to 30,000 RPM for improved efficiency.
- ETL listed; meets and complies with electrical safety standards in the U.S.A. (UL-763) and Canada (CAN/CSA-C22.2)
- NSF listed
- One-year warranty



Item	Description	UOM	Case
MXBD-1500	BlendKing 51oz Blender Set	Set	1/1



MXBD-68

2.5HP Professional Blender

- Removable center lid plug allows easy and continuous ingredient add-ins with included tamper.
- 68oz durable and temperature-resistant BPA-free food grade jug handles large volume of ingredients.
- Industrial grade corrosion-resistant stainless steel blade evenly powers through ice and tough ingredients in seconds.
- 2-in-1 agitator assembly works well with both wet and dry ingredients.
- User-friendly control panel cuts down on operation time.
- Adjustable speed range 27,000- 30,000 RPM for improved efficiency.
- ETL listed; meets and complies with electrical safety standards in the U.S.A. (UL-763) and Canada (CAN/CSA-C22.2)
- NSF listed
- One-year warranty



Item	Description	UOM	Case
MXBD-68	BlendKing 68oz Blender Set	Set	1/1



Industrial Grade Stainless Steel Blade



BPA-Free Food Grade Jug

3.75HP Digital High Power Blender

- Compact sound enclosure is included to reduce decibel exposure during use.
- User-friendly digital panel offers precise speed control and consistent results.
- Removable center lid plug allows easy and continuous ingredient add-ins with included tamper.
- 51oz durable and temperature-resistant BPA-free food grade jug handles large volume of ingredients.
- Industrial grade corrosion-resistant stainless steel blade evenly powers through ice and tough ingredients in seconds.
- 2-in-1 agitator assembly works well with both wet and dry ingredients.
- 4 speed settings allow up to 30,000 RPM for improved efficiency.
- ETL listed; meets and complies with electrical safety standards in the U.S.A. (UL-763) and Canada (CAN/CSA-C22.2)
- NSF listed
- One-year warranty



Compact Sound Enclosure



MXBD-DIG150

Item	Description	UOM	Case
MXBD-DIG150	BlendKing 51oz Digital Blender Set	Set	1/1

SPECIFICATIONS

	MXBD-DIG150	MXBD-1500	MXBD-68
Capacity	51oz/1500ml	51oz/1500ml	68oz/2000ml
Color	Black/Clear	Black/Clear	Black/Clear
Base Dimensions	8-1/2"L x 10-3/4"W	8-1/2"L x 10-3/4"W	9-1/4"L x 10-3/8"W
Max Height	25-5/8"	25-5/8"	20-1/2"
Voltage	110-120V	110-120V	110-120V
Power	1800W	1800W	1500W
Horsepower	3.75hp-Peak	3.75hp-Peak	2.5hp-Peak
RPM	Up to 30,000	Up to 30,000	27,000-30,000
Frequency	60Hz	60Hz	60Hz
Plug Type	NEMA 5-15P	NEMA 5-15P	NEMA 5-15P
Cord Length	4-3/4ft.	4-3/4ft.	3-3/4ft.
Shipping Dimensions	13-7/8" x 11-1/8" x 21-1/8"H	13-7/8" x 11-1/8" x 21-1/8"H	19-1/4" x 12-5/8" x 13-3/4"H
Shipping Weight	19.8lbs	19.8lbs	16.5lbs

Accessory

- NSF listed: MXBD-68RJAS, MXBD-150RJAS



Item	Description	MXBD-DIG150	MXBD-1500	MXBD-68	UOM	Case
MXBD-68PG	Lid Plug for 68oz Jug			•	Each	1
MXBD-150PG	Lid Plug for 51oz Jug	•	•		Each	1
MXBD-68LD	Lid for 68oz Jug			•	Each	1
MXBD-150LD	Lid for 51oz Jug	•	•		Each	1
MXBD-68TMP	Tamper for 68oz Jug			•	Each	1
MXBD-150TMP	Tamper for 51oz Jug	•	•		Each	1
MXBD-68RJAS	Jug Assembly 68oz			•	Each	1/4
MXBD-150RJAS	Jug Assembly 51oz	•	•		Each	1/4



MXBD-68RJAS



MXBD-150RJAS



MXBD-68PG

MXBD-68LD



MXBD-68TMP



MXBD-150PG

MXBD-150LD



MXBD-150TMP

Stainless Steel Steam Table Pan

- Constructed with high-quality rust-resistant 304 stainless steel
- Reinforced corner and edge for added strength and durability
- Crimped edge design for sturdy grip and easy transportation
- Dishwasher-, oven- and freezer-safe
- NSF listed
- Matching covers are available.



Heavier Thicker ← 22 Stainless Steel Gauge 25 → Lighter Thinner

Pan Size	GN Size	Dimensions	Depth	Anti-Jam Gauge				Perforated		Standard
				22 Gauge	23 Gauge	24 Gauge	25 Gauge	24 Gauge	25 Gauge	25 Gauge
	Full	GN 1/1 20-7/8" x 12-3/4" 530mm x 325mm	1-1/4"	•						•
			2-1/2"	•	•	•	•	•	•	•
			4"	•	•	•	•	•	•	•
			6"	•	•	•	•	•	•	•
	Two-Thirds	GN 2/3 13-7/8" x 12-3/4" 354mm x 325mm	2-1/2"			•	•			
			4"			•	•			
			6"			•	•			
	Half	GN 1/2 10-3/8" x 12-3/4" 265mm x 325mm	1-1/4"	•						•
			2-1/2"	•	•	•	•	•	•	•
			4"	•	•	•	•	•	•	•
	Half Long	GN 2/4 20-7/8" x 6-3/8" 530mm x 162mm	2-1/2"	•		•	•			
			4"	•		•	•			
			6"	•		•	•			
	One-Third	GN 1/3 6-7/8" x 12-3/4" 176mm x 325mm	2-1/2"	•	•	•	•			•
			4"	•	•	•	•	•	•	•
			6"	•	•	•	•	•	•	•
	Quarter	GN 1/4 10-3/8" x 6-3/8" 265mm x 162mm	2-1/2"	•	•	•	•			•
			4"	•	•	•	•	•	•	•
			6"	•	•	•	•	•	•	•
	One-Sixth	GN 1/6 6-7/8" x 6-3/8" 176mm x 162mm	2-1/2"	•	•	•	•			•
			4"	•	•	•	•	•	•	•
			6"	•	•	•	•	•	•	•
	One-Ninth	GN 1/9 6-7/8" x 4-1/4" 176mm x 108mm	2-1/2"	•	•	•	•			•
			4"	•	•	•	•			•

Anti-Jam

- Anti-jam stacking lug
- NSF listed



Perforated

- Anti-jam stacking lug
- NSF listed



Standard

- 25 gauge
- NSF listed



Size	Depth	Anti-Jam				Perforated		UOM	Case	Standard		
		22 Gauge	23 Gauge	24 Gauge	25 Gauge	24 Gauge	25 Gauge			25 Gauge	UOM	Case
1/1	1-1/4"	STPF-22-1						Each	6/12	STPF-S25-1	Each	12/24
1/1	2-1/2"	STPF-22-2	STPF-23-2	STPF-24-2	STPF-25-2	SSPF-24-2P	SSPF-25-2P	Each	6/12	STPF-S25-2	Each	6/12
1/1	4"	STPF-22-4	STPF-23-4	STPF-24-4	STPF-25-4	SSPF-24-4P	SSPF-25-4P	Each	6/12	STPF-S25-4	Each	6/12
1/1	6"	STPF-22-6	STPF-23-6	STPF-24-6	STPF-25-6	SSPF-24-6P	SSPF-25-6P	Each	6/12	STPF-S25-6	Each	6/12
2/3	2-1/2"			STP2T-24-2	STP2T-25-2			Each	12/24			
2/3	4"			STP2T-24-4	STP2T-25-4			Each	6/24			
2/3	6"			STP2T-24-6	STP2T-25-6			Each	6/12			
1/2	1-1/4"	STPH-22-1						Each	12/48	STPH-S25-1	Each	12/48
1/2	2-1/2"	STPH-22-2	STPH-23-2	STPH-24-2	STPH-25-2	SSPH-24-2P	SSPH-25-2P	Each	12/24	STPH-S25-2	Each	12/24
1/2	4"	STPH-22-4	STPH-23-4	STPH-24-4	STPH-25-4	SSPH-24-4P	SSPH-25-4P	Each	6/24	STPH-S25-4	Each	6/24
1/2	6"	STPH-22-6	STPH-23-6	STPH-24-6	STPH-25-6	SSPH-24-6P	SSPH-25-6P	Each	6/12	STPH-S25-6	Each	6/12
2/4	2-1/2"	STPHL-22-2		STPHL-24-2	STPHL-25-2			Each	6/24			
2/4	4"	STPHL-22-4		STPHL-24-4	STPHL-25-4			Each	6/24			
2/4	6"	STPHL-22-6		STPHL-24-6	STPHL-25-6			Each	6/12			
1/3	2-1/2"	STPT-22-2	STPT-23-2	STPT-24-2	STPT-25-2			Each	12/48	STPT-S25-2	Each	12/48
1/3	4"	STPT-22-4	STPT-23-4	STPT-24-4	STPT-25-4			Each	12/24	STPT-S25-4	Each	12/24
1/3	6"	STPT-22-6	STPT-23-6	STPT-24-6	STPT-25-6			Each	12/24	STPT-S25-6	Each	12/24
1/4	2-1/2"	STPQ-22-2	STPQ-23-2	STPQ-24-2	STPQ-25-2			Each	12/72	STPQ-S25-2	Each	12/72
1/4	4"	STPQ-22-4	STPQ-23-4	STPQ-24-4	STPQ-25-4			Each	12/48	STPQ-S25-4	Each	12/48
1/4	6"	STPQ-22-6	STPQ-23-6	STPQ-24-6	STPQ-25-6			Each	12/24	STPQ-S25-6	Each	12/24
1/6	2-1/2"	STPS-22-2	STPS-23-2	STPS-24-2	STPS-25-2			Each	12/72	STPS-S25-2	Each	12/72
1/6	4"	STPS-22-4	STPS-23-4	STPS-24-4	STPS-25-4			Each	12/48	STPS-S25-4	Each	12/48
1/6	6"	STPS-22-6	STPS-23-6	STPS-24-6	STPS-25-6			Each	12/48	STPS-S25-6	Each	12/48
1/9	2-1/2"	STPN-22-2	STPN-23-2	STPN-24-2	STPN-25-2			Each	12/72	STPN-S25-2	Each	12/72
1/9	4"	STPN-22-4	STPN-23-4	STPN-24-4	STPN-25-4			Each	12/72	STPN-S25-4	Each	12/72

Steam Table Pan Cover

- NSF listed



Item	Size	Description	UOM	Case
SPCN-F	1/1	Notched	Each	12/24
SPCN-2T	2/3	Notched	Each	12/24
SPCN-H	1/2	Notched	Each	12/48
SPCN-HL	2/4	Notched	Each	12/24
SPCN-T	1/3	Notched	Each	12/72
SPCN-Q	1/4	Notched	Each	12/72
SPCN-S	1/6	Notched	Each	12/72
SPCN-N	1/9	Notched	Each	12/72
SPCO-F	1/1	Solid	Each	12/24
SPCO-2T	2/3	Solid	Each	12/24
SPCO-H	1/2	Solid	Each	12/48
SPCO-HL	2/4	Solid	Each	12/24
SPCO-T	1/3	Solid	Each	12/72
SPCO-Q	1/4	Solid	Each	12/72
SPCO-S	1/6	Solid	Each	12/72
SPCO-N	1/9	Solid	Each	12/72



Notched Cover



Solid Cover



SBAM Series

Bain-Marie

- Durable stainless steel construction
- Open bead for enhanced sanitation
- Smooth surface for easy cleaning and maintenance

Item	Description	Size (Dia x H)	UOM	Case
SBAM-125	1.5QT	5-1/8" x 6"	Each	6/48
SBAM-200	2QT	5-3/4" x 7"	Each	6/48
SBAM-350	3.5QT	7-1/8" x 6-7/8"	Each	6/36
SBAM-400	4.25QT	7-3/8" x 7-5/8"	Each	6/36
SBAM-600	6QT	8-1/8" x 8-7/8"	Each	6/24
SBAM-800	8QT	8-3/4" x 9-5/8"	Each	6/24
SBAM-1200	12QT	10" x 15-5/8"	Each	3/6

Bain-Marie Cover

- Durable stainless steel construction

Item	Description	Size (Dia)	UOM	Case
SBAM-125C	For 1.5QT SBAM-125	5-1/4"	Each	12/144
SBAM-200C	For 2QT SBAM-200	5-3/4"	Each	12/144
SBAM-300C	For 3.5QT SBAM-350	7-1/8"	Each	12/144
SBAM-400C	For 4.25QT SBAM-400	7-3/8"	Each	12/72
SBAM-600C	For 6QT SBAM-600	8-1/8"	Each	12/72
SBAM-800C	For 8QT SBAM-800	8-7/8"	Each	12/48
SBAM-1200C	For 12QT SBAM-1200	10"	Each	12/24

Vegetable Inset Pot

- Made of 24-gauge stainless steel in mirror finish
- Open bead for enhanced sanitation
- Versatile to use with warmer, marmite chafer and steam table, or simply to use as a stand-alone container

Item	Description	Size (Dia x H)	UOM	Case
INSS-25F	2.5QT	6" Dia x 7-1/2"H	Each	6/36
INSS-40F	4QT	7-1/2" Dia x 7-3/4"H	Each	6/36
INSS-70F	7QT	9-1/2" Dia x 8"H	Each	6/24
INSS-110F	11QT	11-1/2" Dia x 9"H	Each	6/12



INSS-40C



INSS-F Series



INSS-40F



INSS-70F Fits Marmite Soup Chafer CAMS-107 (Sold Separately)

Cover for Inset Pot

- Durable stainless steel construction

Item	Description	UOM	Case
INSS-25C	Cover for INSS-25F	Each	6/72
INSS-40C	Cover for INSS-40F	Each	6/36
INSS-70C	Cover for INSS-70F	Each	6/48
INSS-110C	Cover for INSS-110F	Each	6/36



Electric Water Pan

- Durable and rust-resistant polypropylene construction for long-lasting performance
- Flame-free hot holding solution helps to keep food warm during service.
- Heats and keeps water up to 185°F/85°C; meets and exceeds HACCP food-safe reheating and hot-holding temperature requirements.
- Thermostat knob on the control panel helps to adjust temperature while in use.
- Maximized versatility allows for operating by itself or pairing with other full size chafer frames.
- Compatible with standard GN pan (sold separately).
- ETL listed; meets and complies with electrical safety standards in the U.S.A. (UL-197) and Canada (CAN/CSA-C22.2)
- One-year warranty

Item	Description	UOM	Case
ELWP-1	Full Size, Black	Each	1

SPECIFICATIONS

Capacity	1/1 size food pan x 1 or 1/2 size food pan x 2
Color	Black
Dimensions	22-5/8"L x 13-3/4"W x 7"H
Voltage	120V
Power	900W
Frequency	60Hz
Plug Type	5-15P
Cord Length	5ft.
Temperature Range	185°F/85°C-Max
Shipping Dimensions	22-7/8" x 14-5/8" x 7-7/8"H
Shipping Weight	6.6lbs



ELWP-1

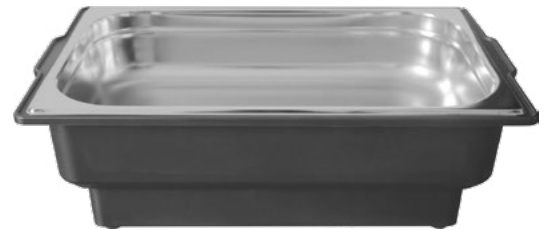

ELWP-1 with 1/1 Size GN Pan
*GN pan sold separately



ELWP-1 & CAFR-501

Compatible with Our Full Size Chafer

Table Pan Grate

- Durable wire construction with footed base for enhanced air circulation
- Great for cooling and draining
- Fits standard sized GN pan

Item	Description	Size	UOM	Case
PGTP-1005	For 1/3 Size Pan	10" x 5"	Each	12/48
PGTP-1008	For 1/2 Size Pan	10" x 8"	Each	12/48
PGTP-1810	For 1/1 Size Pan	18" x 10"	Each	12/48



PGTP-1005

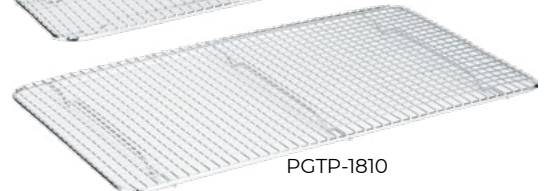

PGTP-1810

Polycarbonate Food Pan

- Heavy-duty construction assures quality and durability.
- Shatter- and scratch-resistant polycarbonate helps resist oil and acid.
- Temperature resistant material withstands -40 to 210°F.
- Dishwasher- and freezer-safe
- NSF listed
- Matching covers and drain shelves are available.



	Pan Size	Dimensions
	Full 1/1	20-3/4" x 12-1/2"
	Half 1/2	10-3/8" x 12-3/4"
	One-Third 1/3	6-7/8" x 12-5/8"
	Quarter 1/4	10-1/4" x 6-1/4"
	One-Sixth 1/6	6-3/4" x 6-1/4"
	One-Ninth 1/9	6-7/8" x 4-1/4"



Food Pan

- Designed with round corner for easy scooping
- Clear body and molded-in graduations for enhanced visibility and convenient measurement
- Smooth non-stick interior for easy cleaning and maintenance
- NSF listed



Item	Size	Depth	UOM	Case
PCFP-F2	1/1	2-1/2"	Each	6/12
PCFP-F4	1/1	4"	Each	6/12
PCFP-F6	1/1	6"	Each	6/12
PCFP-F8	1/1	8"	Each	6/12
PCFP-H2	1/2	2-1/2"	Each	12/24
PCFP-H4	1/2	4"	Each	6/24
PCFP-H6	1/2	6"	Each	6/12
PCFP-H8	1/2	8"	Each	6/12
PCFP-T2	1/3	2-1/2"	Each	12/24
PCFP-T4	1/3	4"	Each	12/24
PCFP-T6	1/3	6"	Each	6/24
PCFP-T8	1/3	8"	Each	6/12
PCFP-Q2	1/4	2-1/2"	Each	12/36
PCFP-Q4	1/4	4"	Each	12/36
PCFP-Q6	1/4	6"	Each	6/24
PCFP-S2	1/6	2-1/2"	Each	12/36
PCFP-S4	1/6	4"	Each	12/48
PCFP-S6	1/6	6"	Each	12/24
PCFP-N2	1/9	2-1/2"	Each	12/72
PCFP-N4	1/9	4"	Each	12/72



Food Pan Cover

- NSF listed



Item	Size	Description	UOM	Case
PCSL-FC	1/1	Notched	Each	12/24
PCSL-HC	1/2	Notched	Each	12/48
PCSL-TC	1/3	Notched	Each	12/72
PCSL-QC	1/4	Notched	Each	12/72
PCSL-SC	1/6	Notched	Each	12/72
PCSL-NC	1/9	Notched	Each	12/72
PCSD-FC	1/1	Solid	Each	12/24
PCSD-HC	1/2	Solid	Each	12/48
PCSD-TC	1/3	Solid	Each	12/72
PCSD-QC	1/4	Solid	Each	12/72
PCSD-SC	1/6	Solid	Each	12/72
PCSD-NC	1/9	Solid	Each	12/72



Drain Shelf

- NSF listed



Item	Size	UOM	Case
PCDS-F	1/1	Each	10/20
PCDS-H	1/2	Each	10/40
PCDS-T	1/3	Each	20/80
PCDS-Q	1/4	Each	20/80
PCDS-S	1/6	Each	20/120



Deluxe Stainless Steel Cookware

- Commercial-grade stainless steel construction offers exceptional performance.
- Tri-ply bottom for even thermal conductivity
- Sturdy handles for safe and convenient transporting
- Smooth surface and non-reactive stainless steel interior for easy maintenance
- Induction ready; NSF listed



Stock Pot with Lid

- Tall and narrow shape allows for slow liquid evaporation for maximum flavor.
- Induction ready; NSF listed



Item	Description	Size (Dia x H)	UOM	Case
STKP-8	8QT	9-1/2" x 6-1/4"	Set	1/4
STKP-12	12QT	11" x 7-1/8"	Set	1/4
STKP-16	16QT	11" x 9-7/8"	Set	1/4
STKP-20	20QT	11-3/4" x 10-1/4"	Set	1/4
STKP-25	25QT	13-3/8" x 10-1/4"	Set	1/2
STKP-32	32QT	14-1/8" x 11-3/4"	Set	1/2
STKP-40	40QT	15-3/4" x 11-3/4"	Set	1/2
STKP-60	60QT	17-3/4" x 14-1/8"	Set	1
STKP-83	83QT	19-5/8" x 15-3/4"	Set	1

Lid

- NSF listed



Item	UOM	Case
SLID-8S	Each	6/12
SLID-16S	Each	6/12
SLID-16S	Each	6/12
SLID-20S	Each	6
SLID-25S	Each	6
SLID-32S	Each	6
SLID-40S	Each	6
SLID-60S	Each	6
SLID-80S	Each	6

Brazier with Lid

- Wide opening design perfect for searing and incorporating flavors
- Induction ready; NSF listed



Item	Description	Size (Dia x H)	UOM	Case
SSBZ-8	8QT	11" x 5-1/8"	Set	1/4
SSBZ-15	15QT	14-1/8" x 5-1/2"	Set	1/4
SSBZ-20	20QT	15-3/4" x 5-7/8"	Set	1/4
SSBZ-25	25QT	17-3/4" x 5-7/8"	Set	1/2
SSBZ-30	30QT	19-5/8" x 5-7/8"	Set	1/2

Lid

- NSF listed



Item	UOM	Case
SLID-16S	Each	6/12
SLID-32S	Each	6
SLID-40S	Each	6
SLID-60S	Each	6
SLID-80S	Each	6



Saucepan with Lid

- Helper handle on large-capacity models for safe transporting
- Induction ready; NSF listed



Item	Description	Size (Dia x H)	UOM	Case
S3AP-2	2QT	6-1/4" x 3-3/4"	Each	1/6
S3AP-3	3.5QT	7-7/8" x 4-1/8"	Each	1/6
S3AP-4	4.5QT	7-7/8" x 5-1/2"	Each	1/6
S3AP-6	6QT	9-1/2" x 5-1/8"	Each	1/6
S3AP-7H	7.5QT, Helper Handle	9-1/2" x 6-1/8"	Each	1/2
S3AP-10H	10QT, Helper Handle	11" x 6-1/8"	Each	1/2

Lid

- NSF listed



Item	UOM	Case
SLID-2S	Each	6/12
SLID-4S	Each	6/12
SLID-4S	Each	6/12
SLID-8S	Each	6/12
SLID-8S	Each	6/12
SLID-16S	Each	6/12



SPDB-16



SPDB-8S

Pasta Cooker with Lid

- Perforated inset for easy draining and steaming
- Induction ready; NSF listed



Item	Description	Size (Dia x H)	Inset Height	UOM	Case
SPDB-8	8QT	9-1/2" x 7-1/2"	6-3/4"	Set	1/6
SPDB-12	12QT	10-1/4" x 9-1/4"	8-1/2"	Set	1/6
SPDB-16	16QT	11" x 10-3/8"	9-5/8"	Set	1/4
SPDB-20	20QT	11-3/4" x 11-3/8"	10-5/8"	Set	1/4

Lid

- NSF listed



Item	UOM	Case
SLID-8S	Each	6/12
SLID-12S	Each	6/12
SLID-16S	Each	6/12
SLID-20S	Each	6

Double Boiler with Lid

- Solid inset ideal for slow cooking and handling delicate ingredients
- Induction ready; NSF listed



Item	Description	Size (Dia x H)	Inset Height	UOM	Case
SPDB-8S	8QT	9-1/2" x 7-1/2"	6-3/4"	Set	1/6
SPDB-12S	12QT	10-1/4" x 9-1/4"	8-1/2"	Set	1/6
SPDB-16S	16QT	11" x 10-3/8"	9-5/8"	Set	1/4
SPDB-20S	20QT	11-3/4" x 11-3/8"	10-5/8"	Set	1/4

Lid

- NSF listed



Item	UOM	Case
SLID-8S	Each	6/12
SLID-12S	Each	6/12
SLID-16S	Each	6/12
SLID-20S	Each	6

Fry Pan

- Versatile kitchen staple ideal for frying, searing, browning, sautéing and more
- Helper handle on large-capacity models for secure grip
- Induction ready; NSF listed



Item	Description	UOM	Case
SIFP-8	8" x 1-5/8"	Each	6
SIFP-9	9-1/2" x 2"	Each	6
SIFP-11	11" x 2"	Each	6
SIFP-12H	12-5/8" x 2", Helper Handle	Each	6
SIFP-14H	14-1/8" x 2-3/8", Helper Handle	Each	6



Non-Stick Fry Pan

- Advanced Quantum 2 non-stick coating is internally reinforced to withstand abrasives and high wear. It is oven-safe, dishwasher-safe and free of PFOA.
- Versatile kitchen staple ideal for frying, searing, browning, sautéing and more
- Helper handle on large-capacity models for secure grip
- Induction ready; NSF listed; PFOA free



Item	Description	UOM	Case
S2FP-8N	8" x 1-5/8"	Each	6
S2FP-9N	9-1/2" x 2"	Each	6
S2FP-11N	11" x 2"	Each	6
S2FP-12HN	12-5/8" x 2", Helper Handle	Each	6
S2FP-14HN	14-1/8" x 2-3/8", Helper Handle	Each	6



Aluminum Pro Extra Heavy-Duty Cookware

- 6.0mm/1/4" thick heavy-gauge and impact-resistant 3003 aluminum construction withstands high volume use in busy commercial settings.
- Dent-resistant surface distributes heat evenly and efficiently.
- Riveted handles provide a rigid connection for steady transporting. 4 handles on large-capacity models for reinforced durability and safe transporting.
- With thicker rim, bottom, and handles, C.A.C. Aluminum Pro Cookware Series is built to last.
- NSF listed



Extra Heavy-Duty Stock Pot

- NSF listed



Item	Description	Size (Dia x H)	UOM	Case
A1SP-6-12	12QT	10-3/8" x 9-3/8"	Each	1
A1SP-6-16	16QT	11-1/2" x 10-1/4"	Each	1
A1SP-6-20	20QT	12-3/8" x 11"	Each	1
A1SP-6-24	24QT	13-1/8" x 11-3/8"	Each	1
A1SP-6-32	32QT	14-3/8" x 13"	Each	1
A1SP-6-40	40QT	15" x 14-5/8"	Each	1
A1SP-6-60	60QT	16-3/8" x 17-3/8"	Each	1
A1SP-6-80	80QT	19-3/8" x 17-1/8"	Each	1
A1SP-6-100	100QT	20-3/8" x 18-3/8"	Each	1
A1SP-6-120	120QT	22-1/8" x 19-1/2"	Each	1
A1SP-6-140	140QT	24-1/8" x 19-1/2"	Each	1
A1SP-6-160	160QT	24-1/8" x 21-7/8"	Each	1

Lid

- NSF listed



Item	UOM	Case
ALID-12	Each	6
ALID-16	Each	6
ALID-20	Each	6
ALID-24	Each	6
ALID-32	Each	6
ALID-40	Each	6
ALID-60	Each	6
ALID-80	Each	6
ALID-100	Each	6
ALID-120	Each	6
ALID-140	Each	6
ALID-160	Each	6

Extra Heavy-Duty Stock Pot with 4 Handles

Item	Description	Size (Dia x H)	UOM	Case
A2SP-6-120H	120QT	22-1/8" x 19-1/2"	Each	1
A2SP-6-140H	140QT	24-1/8" x 19-1/2"	Each	1
A2SP-6-160H	160QT	24-1/8" x 21-7/8"	Each	1

Lid

- NSF listed



Item	UOM	Case
ALID-120	Each	6
ALID-140	Each	6
ALID-160	Each	6

Extra Heavy-Duty Sauce Pot

- NSF listed



Item	Description	Size (Dia x H)	UOM	Case
A3SA-6-08	8QT	10-1/2" x 6-1/4"	Each	1
A3SA-6-14	14QT	12-3/8" x 7-1/2"	Each	1
A3SA-6-20	20QT	13-3/8" x 9"	Each	1
A3SA-6-26	26QT	14-3/8" x 10"	Each	1
A3SA-6-34	34QT	16-3/8" x 9-7/8"	Each	1
A3SA-6-40	40QT	18-3/8" x 10"	Each	1
A3SA-6-60	60QT	20-3/8" x 11-1/8"	Each	1

Lid

- NSF listed



Item	UOM	Case
ALID-08M	Each	6
ALID-14M	Each	6
ALID-20M	Each	6
ALID-26M	Each	6
ALID-34M	Each	6
ALID-40M	Each	6
ALID-60M	Each	6

Extra Heavy-Duty Brazier

- NSF listed



Item	Description	Size (Dia x H)	UOM	Case
A4BZ-6-15	15QT	14-3/8" x 5-3/8"	Each	1
A4BZ-6-18	18QT	16-3/8" x 5-3/8"	Each	1
A4BZ-6-24	24QT	18-3/8" x 5-3/8"	Each	1
A4BZ-6-30	30QT	20-3/8" x 5-3/8"	Each	1
A4BZ-6-35	35QT	22-1/8" x 5-1/2"	Each	1
A4BZ-6-40	40QT	23-1/4" x 5-1/2"	Each	1

Lid

- NSF listed



Item	UOM	Case
ALID-32	Each	6
ALID-60	Each	6
ALID-40M	Each	6
ALID-60M	Each	6
ALID-120	Each	6
ALID-80M	Each	6



Aluminum Pro Heavy-Duty Cookware

- 4.0 mm/ 1/8" thick durable and heavy-duty 3003 aluminum construction
- Dent-resistant surface distributes heat evenly and efficiently.
- Riveted handles provide a rigid connection for steady transporting.
- With thicker rim, bottom, and handles, C.A.C. Aluminum Pro Cookware Series is built to last.
- NSF listed



Heavy-Duty Stock Pot 🛒

-NSF listed



Item	Description	Size (Dia x H)	UOM	Case
A5SP-4-08	8.5QT	9-3/8" x 7-1/2"	Each	1
A5SP-4-10	10QT	10-1/4" x 8-1/4"	Each	1
A5SP-4-12	12QT	10-1/8" x 9-3/8"	Each	1
A5SP-4-16	16QT	11-3/8" x 10-1/4"	Each	1
A5SP-4-20	20QT	12-1/4" x 11"	Each	1
A5SP-4-24	24QT	12-7/8" x 11-3/8"	Each	1
A5SP-4-32	32QT	14-1/8" x 13"	Each	1
A5SP-4-40	40QT	14-3/4" x 14-5/8"	Each	1
A5SP-4-50	50QT	16-1/4" x 15"	Each	1
A5SP-4-60	60QT	16-1/4" x 17-3/8"	Each	1
A5SP-4-80	80QT	19-1/4" x 17-1/8"	Each	1
A5SP-4-100	100QT	20-1/4" x 18-3/8"	Each	1

Lid

-NSF listed



Item	UOM	Case
ALID-08	Each	6
ALID-12	Each	6
ALID-12	Each	6
ALID-16	Each	6
ALID-20	Each	6
ALID-24	Each	6
ALID-32	Each	6
ALID-40	Each	6
ALID-60	Each	6
ALID-60	Each	6
ALID-80	Each	6
ALID-100	Each	6

Heavy-Duty Sauce Pot 🛒

-NSF listed



Item	Description	Size (Dia x H)	UOM	Case
A6SA-4-08	8QT	10-3/8" x 6-1/4"	Each	1
A6SA-4-14	14QT	12-1/4" x 7-1/2"	Each	1
A6SA-4-20	20QT	13-1/4" x 9"	Each	1
A6SA-4-26	26QT	14-1/2" x 10"	Each	1
A6SA-4-34	34QT	16-1/4" x 9-7/8"	Each	1
A6SA-4-40	40QT	18-3/8" x 10"	Each	1

Lid

-NSF listed



Item	UOM	Case
ALID-08M	Each	6
ALID-14M	Each	6
ALID-20M	Each	6
ALID-26M	Each	6
ALID-34M	Each	6
ALID-40M	Each	6

Heavy-Duty Brazier 🛒

-NSF listed



Item	Description	Size (Dia x H)	UOM	Case
A7BZ-4-15	15QT	14-1/8" x 5-3/8"	Each	1
A7BZ-4-18	18QT	16-1/4" x 5-3/8"	Each	1
A7BZ-4-24	24QT	18-1/4" x 5-3/8"	Each	1
A7BZ-4-30	30QT	20-1/4" x 5-3/8"	Each	1
A7BZ-4-35	35QT	22" x 5-1/2"	Each	1
A7BZ-4-40	40QT	23-1/8" x 5-1/2"	Each	1

Lid

-NSF listed



Item	UOM	Case
ALID-32	Each	6
ALID-60	Each	6
ALID-40M	Each	6
ALID-60M	Each	6
ALID-120	Each	6
ALID-80M	Each	6





Stir Fry Pan 🛒

- Advanced Quantum 2 non-stick coating is internally reinforced to withstand abrasives and high wear. Quantum 2 is oven-safe, dishwasher-safe and free of PFOA.
- 3003 aluminum construction
- NSF listed



Item	Description	UOM	Case
A8FP-4-11	11"	Each	6
A8FP-4-11N	11", Non-Stick, Quantum 2	Each	6



Fry Pan 🛒

- Heavy-duty 3003 aluminum construction stands up to daily use in busy commercial settings.
- Heat-resistant silicone sleeve on some models for safe and secure grip
- NSF listed



Item	Description	UOM	Case
A1FP-7	7"	Each	6
A1FP-8	8"	Each	6
A1FP-10	10"	Each	6
A1FP-12	12"	Each	6
A1FP-14	14"	Each	6
A2FP-8L	8" w/ Sleeve	Each	6
A2FP-10L	10" w/ Sleeve	Each	6
A2FP-12L	12" w/ Sleeve	Each	6
A2FP-14L	14" w/ Sleeve	Each	6



Non-Stick Fry Pan 🛒

- Advanced Quantum 2 non-stick coating is internally reinforced to withstand abrasives and high wear. Quantum 2 is oven-safe, dishwasher-safe and free of PFOA.
- 3003 aluminum construction
- Heat-resistant silicone sleeve on some models for safe and secure grip
- NSF listed



Item	Description	UOM	Case
A3FP-7N	7", Non-Stick	Each	6
A3FP-8N	8", Non-Stick	Each	6
A3FP-10N	10", Non-Stick	Each	6
A3FP-12N	12", Non-Stick	Each	6
A3FP-14N	14", Non-Stick	Each	6
A4FP-8NL	8", Non-Stick w/ Sleeve	Each	6
A4FP-10NL	10", Non-Stick w/ Sleeve	Each	6
A4FP-12NL	12", Non-Stick w/ Sleeve	Each	6
A4FP-14NL	14", Non-Stick w/ Sleeve	Each	6

Saucepan

- Tapered 3003 aluminum construction ideal for fast-paced food service environments
- NSF listed



Item	Description	Size (Dia x H)	UOM	Case
A9SA-3-1	1.5QT	6-1/8" x 4"	Each	12
A9SA-3-2	2.75QT	8-1/8" x 4-1/4"	Each	12
A9SA-3-3	3.75QT	8-7/8" x 4-1/2"	Each	12
A9SA-3-4	4.5QT	9-1/4" x 5"	Each	12
A9SA-3-5	5.5QT	10" x 5-1/2"	Each	12
A9SA-3-7	7QT	10-7/8" x 5-5/8"	Each	6
A9SA-3-10	10QT	12" x 6-1/8", Helper Handle	Each	6



A9SA-3-1



A9SA-3-10

Saucepan Lid

- 3003 aluminum construction
- NSF listed



Item	Description	UOM	Case
ALD9-1	For 1.5QT A9SA-3-1	Each	6
ALD9-2	For 2.75QT A9SA-3-2	Each	6
ALD9-3	For 3.75QT A9SA-3-3	Each	6
ALD9-4	For 4.5QT A9SA-3-4	Each	6
ALD9-5	For 5.5QT A9SA-3-5	Each	6
ALD9-7	For 7QT A9SA-3-7	Each	6
ALD9-10	For 10QT A9SA-3-10	Each	6



ALD9-1



ALD9-10



Clipped-on ALPS-INS

Pasta Cooker with Four Insets

- Aluminum pot body
- Stainless steel insets
- Heat-resistant inset handles withstand up to 500°F/260°C.

Item	Description	UOM	Case
ALPC-20ST 	5-PC Set, 20QT Pot w/ 4 insets	Set	1
ALPS-INS	Quarter Size Inset	Each	4
ALPS-POT	Pot for ALPC-20ST, ALPS-INS	Each	1



ALPC-20ST

Wok

- 1.2mm black carbon steel construction

Item	Description	UOM	Case
WOK-14BK	14" Dia	Each	12
WOK-16BK	16" Dia	Each	12



WOK Series

Round Fry Basket

- Nickel-plated metal construction with front hook
- Reinforced base for enhanced durability
- Compatible with C.A.C. fry pot/saucepan



1/8" Mesh Basket

Item	Description	UOM	Case
FBR8-008	8-1/2" x 5-1/8"	Each	20
FBR8-009	9-1/2" x 5-1/8"	Each	20
FBR8-011	11-1/2" x 5-7/8"	Each	20

1/4" Mesh Basket

Item	Description	UOM	Case
FBR4-8	8-1/2" x 5-1/8"	Each	20
FBR4-9	9-1/2" x 5-1/8"	Each	20
FBR4-11	11-1/2" x 6"	Each	20



COMPATIBILITY CHART

POT/PAN	BASKETS	
A9SA-3-5	FBR4-8	FBR8-008
A9SA-3-7	FBR4-9	FBR8-009
A9SA-3-10	FBR4-11	FBR8-011

Culinary/Breading Basket

- Metal construction with non-stick coating for a fast, clean and efficient breading and battering process
- Reinforced base for enhanced durability
- Versatile functions ideal for battering, breading, boiling, frying, blanching, straining, skimming and more
- Easy to maintain and clean



Fine Mesh Basket

Item	Description	UOM	Case
CBKR-8F	8"Dia	Each	12/36
CBKR-10F	10"Dia	Each	12/36
CBKR-12F	12"Dia	Each	30

Medium Mesh Basket

Item	Description	UOM	Case
CBKR-8M	8"Dia	Each	12/36
CBKR-10M	10"Dia	Each	12/36
CBKR-12M	12"Dia	Each	30

Coarse Mesh Basket

Item	Description	UOM	Case
CBKR-8C	8"Dia	Each	12/36
CBKR-10C	10"Dia	Each	12/36
CBKR-12C	12"Dia	Each	30

Fry Basket

- Heavy-duty wire-reinforced corner
- Temperature-resistant color-coded handle
- This series fits multiple fryer machines on the market.

Fry Basket

Item	Description	UOM	Case
SPFB-1	Black Handle	Each	6
SPFB-2	Orange Handle	Each	6
SPFB-3	Blue Handle	Each	6
SPFB-4	Red Handle	Each	6
SPFB-5	Green Handle	Each	6
SPFB-6	Black Handle	Each	6

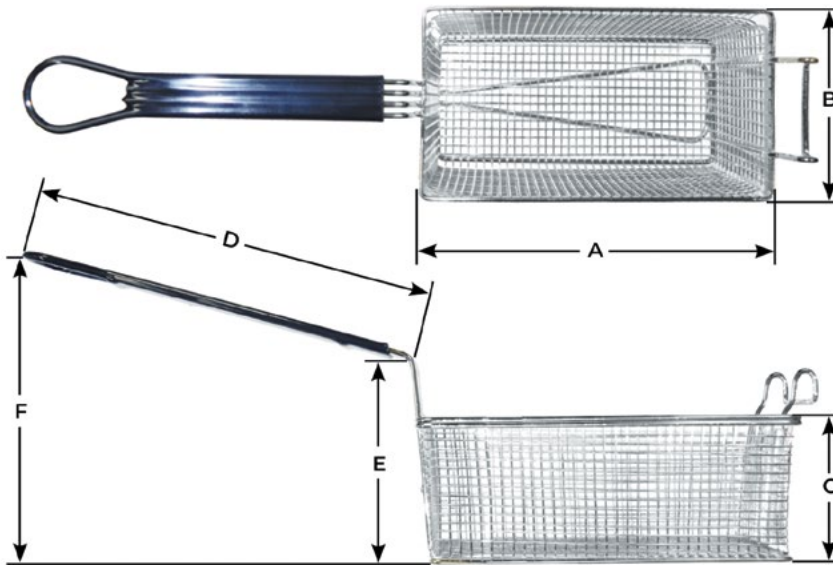

Item	Dimensions					
	A	B	C	D	E	F
SPFB-1	11"	5-3/4"	4-3/8"	10-5/8"	5-7/8"	8-1/8"
SPFB-2	12-1/4"	6-1/2"	5-5/8"	11-1/4"	7-7/8"	11-5/8"
SPFB-3	13-1/4"	5-3/4"	5-1/2"	10-5/8"	7-7/8"	11-3/4"
SPFB-4	12-7/8"	6-5/8"	5-3/8"	11"	8-1/4"	11-1/4"
SPFB-5	13"	6-3/4"	5-1/8"	10-5/8"	5-1/2"	10-1/4"
SPFB-6	13-3/8"	9-1/2"	6-1/4"	11"	8-7/8"	11-3/4"

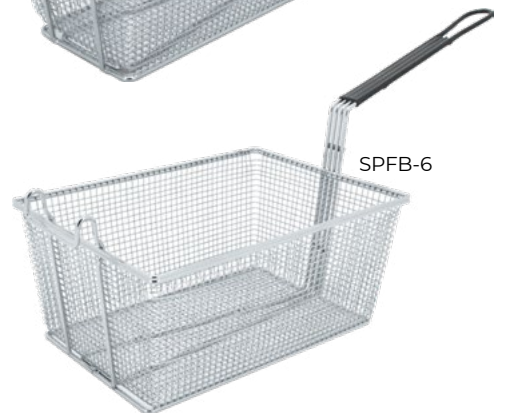
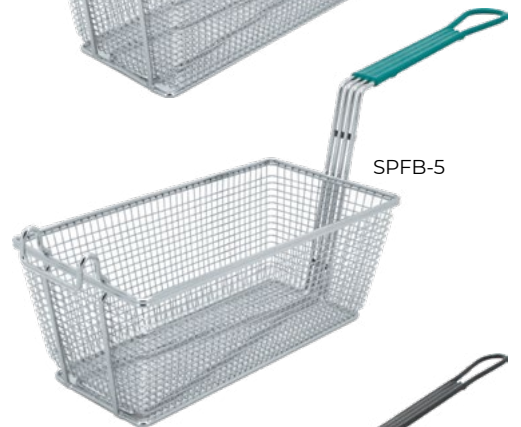



HCCT-1CP



HCCT-2SL

Pan Handle Cover

- Convenient heat guardian for cookware without handle sleeve
- HCCT-2SL: Silicone-coating for easy grasping and quick cleaning
- Heat resistant up to 200°F/94°C

Item	Description	UOM	Case
HCCT-1CP	Cotton/ Chili Pepper, 6-1/2" x 3-1/2"	Doz	1/24
HCCT-2SL	Cotton/ Silicone-Coated, 6-1/2" x 3-1/2"	Doz	1/24



Silicone-Coating for Easy Grasping



PHSC-8



PHTR-8F

Pot Holder

- PHSC-8: Easy-to-clean silicone-coating
- PHTR-8F: Flame retardant on green side for enhanced protection
- Heat resistant up to 200°F/94°C for PHSC-8 and 400°F/205°C for PHTR-8F

Item	Description	UOM	Case
PHSC-8	Cotton/ Silicone-Coated, 8" x 8"	Doz	1/25
PHTR-8F	Terry Cloth/ Flame Retardant, 2 Sided, 8" x 8"	Doz	1/25



PGTR-9P



PGTR-11S

Pan Grabber

- PGTR-9P: Built-in pocket for full hand coverage and safe operation
- PGTR-11S: Elastic wrist strap for added security
- Heat resistant up to 400°F/205°C for PGTR-9P and 600°F/315°C for PGTR-11S

Item	Description	UOM	Case
PGTR-9P	Terry Cloth w/ Pocket 8-1/2" x 9-1/2"	Doz	1/15
PGTR-11S	Terry Cloth w/ Wrist Strap 8" x 11"	Doz	1/15



PGTR-11S Elastic Wrist Strap for Added Security



PGTR-9P Full Hand Coverage

Sheet Pan Rack



- Heavy-duty aluminum construction offers improved durability and sturdiness while holding, transporting, or storing bakery products.
- 4 swivel casters (5" in diameter) move in all directions, forward, backward and sideways, for ease of transporting.
- 2 of the 4 casters are equipped with brake.
- 3" spacing between tiers; 10-tier model holds 10 full size (26" x 18") sheet pans; 20-tier holds 20.
- Ships flat or welded
- NSF listed: ASPR-10BK, ASPR-20BK
- ASPR-10BK-W and ASPR-20BK-W: ship by freight only; UPS small package not available

Item	Description	UOM	Case
ASPR-10BK	10-Tier	Set	1
ASPR-20BK	20-Tier	Set	1
ASPR-10BK-W	10-Tier, Welded	Set	1
ASPR-20BK-W	20-Tier, Welded	Set	1
ASPZ-220BK	20-Tier, Nesting	Set	1
ASPR-10C	Caster for ASPR/ASPZ Series	Each	12
ASPR-10CB	Brake Caster for ASPR/ASPZ Series	Each	12
ASPR-10CV	Cover for ASPR-10BK	Each	12
ASPR-20CV	Cover for ASPR-20BK	Each	12



ASPR-10BK Series

SPECIFICATIONS

	10-Tier	20-Tier
Dimensions (Fully Assembled)	26"L x 20"W x 38-1/2"H	26"L x 20"W x 69"H
Shipping Dimensions	ASPR-10BK: 37-3/8" x 27-1/2" x 3-7/8"H	ASPR-20BK: 66-7/8" x 27-1/2" x 3-7/8"H ASPZ-220BK: 68-1/8" x 27-1/2" x 4-3/8"H
Shipping Weight	ASPR-10BK: 20.3lbs	ASPR-20B: 30.6lbs ASPZ-220BK: 33.2lbs



ASPZ-220BK Series



ASPR-20BK Series

Sheet Pan Truck

- Aluminum body with extruded aluminum frame maneuvers sheet pans easily and efficiently.
- 4 non-marking swivel casters, 5"Dia x 1-3/8"W
- Holds 54 full size (26" x 18") sheet pans or 108 half size (18" x 13") sheet pans
- Ships flat

Item	Description	UOM	Case
ASPT-6	28"L x 20-1/4"W x 33"H	Set	1
ASPT-6C	Caster for ASPT-6	Each	12

SPECIFICATIONS

	ASPT-6
Dimensions (Fully Assembled)	28"L x 20-1/4"W x 33"H
Shipping Dimensions	28" x 21-1/2" x 5-1/8"H
Shipping Weight	20.5lbs



ASPT-6

Sheet Pan

- Made of heavy-duty, bend-resistant aluminum
- Withstands temperatures from freezer to oven
- Stackable with tapered sides



BMSC-1625

Baking Mat

- Non-stick, reusable, food-grade baking pan liner
- Flexible and durable silicone with naturally non-stick surface for repeating use up to thousands of times
- Temperature resistant; withstands temperatures from -40°F/-40°C to 480°F/249°C
- Versatile oven- and freezer-safe tool ideal for baking, freezing and rolling
- Fits standard sized sheet pan
- NSF listed; BPA free



Item	Description	Size	UOM	Case
BMSC-0509	For 1/8 Size	8-3/4" x 4-3/4"	Each	20/100
BMSC-0812	For 1/4 Size	11-3/4" x 8-1/4"	Each	20/100
BMSC-1217	For 1/2 Size	16-1/2" x 11-5/8"	Each	10/50
BMSC-1421	For 2/3 Size	20-1/2" x 14-3/8"	Each	10/50
BMSC-1625	For 1/1 Size	24-1/2" x 16-3/8"	Each	10/50

Open Bead Sheet Pan

–Open bead for enhanced sanitation

Item	Description	Gauge	Size	UOM	Case
ASHP-0610S-O	1/8 Size, Solid	16	6-1/2" x 9-1/2"	Each	24
ASHP-1013S-O	1/4 Size, Solid	16	13" x 9-1/2"	Each	24
ASHP-1826T-O	1/1 Size, Solid	12	26" x 18"	Each	12



Open Bead



Closed Bead

Sheet Pan

–Wire-reinforced rim with rolled edge

Item	Description	Gauge	Size	UOM	Case
ASHP-0610	1/8 Size	20	10" x 6"	Each	24
ASHP-0610S	1/8 Size	16	10" x 6"	Each	24
ASHP-1013	1/4 Size	20	13" x 10"	Each	24
ASHP-1013E	1/4 Size	18	13" x 10"	Each	24
ASHP-1318	1/2 Size	20	18" x 13"	Each	12
ASHP-1318E	1/2 Size	18	18" x 13"	Each	12
ASHP-1622	2/3 Size	20	22" x 16"	Each	12
ASHP-1622N	2/3 Size	19	22" x 16"	Each	12
ASHP-1622E	2/3 Size	18	22" x 16"	Each	12
ASHP-1826	1/1 Size	20	26" x 18"	Each	12
ASHP-1826E	1/1 Size	18	26" x 18"	Each	12
ASHP-1826S	1/1 Size	16	26" x 18"	Each	12



ASHP Solid Series

Perforated Sheet Pan

–Wire-reinforced rim with rolled edge
–Perforated with 1/8" diameter holes

Item	Description	Gauge	Size	UOM	Case
ASHP-1318P	1/2 Size	20	18" x 13"	Each	12
ASHP-1318PE	1/2 Size	18	18" x 13"	Each	12
ASHP-1826P	1/1 Size	20	26" x 18"	Each	12
ASHP-1826PE	1/1 Size	18	26" x 18"	Each	12
ASHP-1826PS	1/1 Size	16	26" x 18"	Each	12



ASHP Perforated Series

Sheet Pan Grate

–Durable wire construction with footed base for enhanced air circulation
–Great for cooling or draining
–Fits standard sized sheet pan

Item	Description	Size	UOM	Case
PGSH-1612	For 1/2 Size	16" x 12"	Each	12/48
PGSH-2014	For 2/3 Size	20" x 14"	Each	12/24
PGSH-2416	For 1/1 Size	24" x 16"	Each	12/24



PGSH-1612

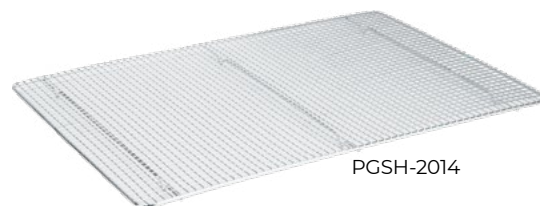

PGSH-2014

Round Cake Pan

- Durable cake pan with strong rolled edge for excellent warp- and rust-resistance
- Fast and even heat distribution helps to avoid hot spots; cools down quickly to avoid over-baking and save operation time.
- Wide selection of pan diameters with generous depth of 2" or 3", making it easy to create nicely-leveled layered/ tiered cakes
- Straight-sided design with round shape ideal for versatile baking needs



B2CP Series



BICP Series

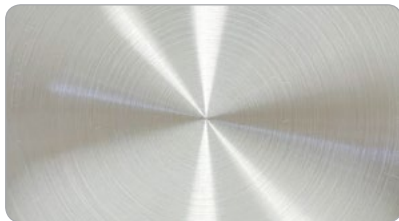

Natural Finish

Hard Anodized Aluminum Cake Pan

- Premium hard-anodized construction offers a smooth, scratch-resistant and non-reactive surface.
- 18 gauge in thickness

Item	Description	UOM	Case
B2CP-042K	4" Dia x 2"H	Each	6/24
B2CP-062K	6" Dia x 2"H	Each	6/24
B2CP-082K	8" Dia x 2"H	Each	6/24
B2CP-102K	10" Dia x 2"H	Each	6/24
B2CP-122K	12" Dia x 2"H	Each	6/24
B2CP-142K	14" Dia x 2"H	Each	6/24
B2CP-162K	16" Dia x 2"H	Each	6/12

3"H Aluminum Cake Pan

- Natural finish

Item	Description	UOM	Case
BICP-063	6" Dia x 3"H	Each	6/36
BICP-083	8" Dia x 3"H	Each	6/36
BICP-093	9" Dia x 3"H	Each	6/36
BICP-103	10" Dia x 3"H	Each	6/36
BICP-123	12" Dia x 3"H	Each	6/24

2"H Aluminum Cake Pan

- Natural finish

Item	Description	UOM	Case
BICP-082	8" Dia x 2"H	Each	6/36
BICP-092	9" Dia x 2"H	Each	6/36
BICP-102	10" Dia x 2"H	Each	6/36
BICP-122	12" Dia x 2"H	Each	6/36

Carbon Steel Specialty Cake Pan

- Strong carbon steel construction for added durability and long-lasting performance
- Bundt design perfect for angel food cake, tube cake, bundt cake and more
- Perfect in size and delivers consistent results every time
- Fast and even heat distribution by disseminating heat from the center as well as the side of the pan
- Naturally non-stick surface
- Easy wipe clean
- PFOA free



B12AP-10N



B13TM-8N

Angel Food Cake Pan

- Plain baking surface

Item	Description	UOM	Case
B12AP-10N	10" Dia x 4"H	Each	12/24

Kugelhopf/Turk's Head Cake Pan

- Fluted baking surface with prism pattern

Item	Description	UOM	Case
B13TM-8N	8-1/2" Dia x 4"H	Each	12/24

Springform Pan

- Helps to keep baked goods in shape and offers fast and clean release with removable bottom, sides and interlocking band.
- Anodized aluminum pan conducts heat quickly for improved efficiency. Temperature resistant up to 450°F/232°C.
- Tin pan is lighter in weight for easier operation and transporting. Temperature resistant up to 482°F/250°C.

Item	Description	UOM	Case
TNSP-083	8" Dia x 3"H, Tin	Each	12/36
TNSP-093	9-1/2" Dia x 3"H, Tin	Each	12/24
TNSP-103	10" Dia x 3"H, Tin	Each	12/24
ASFA-063	6" Dia x 3"H, Anodized Aluminum	Each	36
ASFA-093	9" Dia x 3"H, Anodized Aluminum	Each	24



ASFA-093



TNSP-093



French Baguette Pan

- Heavy-duty and warp-resistant aluminum construction withstands busy commercial use.
- Perforated surface enhances heat conductivity and airflow for crispy crust.
- Non-stick finish for quick and clean release
- Pan size: 26" x 18"

Item	Description	UOM	Case
ALBP-4	4-Loaf	Each	6
ALBP-5W	5-Loaf, Wide	Each	6
ALBP-5	5-Loaf	Each	6
ALBP-6	6-Loaf	Each	6



ALBP-4



ALBP-5



ALBP-5W



ALBP-6

Muffin Pan

- Made of high tensile strength aluminum
- Ideal for high-volume commercial use
- Corrosion- and wear-resistant

Item	Description	Size	UOM	Case
AMFP-12	12 Cup/3.5oz	14" x 10-7/8"	Each	12/24
AMFP-24	24 Cup/3.5oz	20-5/8" x 14"	Each	12



AMFP-24

Bread Mold

- Five 12" long compartments perfect for making foot long sub sandwich rolls
- Multipurpose to prove, freeze, thaw/rise and bake all in one
- No oil required and easy-to-clean thanks to quality silicone construction with non-stick coating
- Heat resistant up to 480°F/249°C

Item	Description	UOM	Case
BMSW-5SC	5-Roll, 13" x 18"	Each	12/144



BMSW-5SC



B5CM-1012



B5CM-1416

Double-Sided Cake/Pie Marker

- Durable poly construction in double-sided design
- Scores and marks cakes/pies into equal portions for consistent results every time
- Ideal for cakes/pies up to 10" in diameter for enhanced efficiency

Item	Description	UOM	Case
B5CM-1012	10/12 Cuts	Each	12/24
B5CM-1416	14/16 Cuts	Each	12/24



B15PZ-2W



B15PZ-2K



B15PZ-4W



B15PZ-4K

Pizza/Pastry Cutter

- Effortlessly cuts pizza, pastry, dough and more with refined sharp blade
- Ergonomically curved handle with finger stop for a safe and comfortable grip
- Smooth rolling for easy operation and enhanced efficiency

Item	Description	UOM	Case
B15PZ-2K	2-1/2" Dia, Black Handle	Each	12/72
B15PZ-4K	4" Dia, Black Handle	Each	12/72
B15PZ-2W	2-1/2" Dia, White Handle	Each	12/72
B15PZ-4W	4" Dia, White Handle	Each	12/72



B10CT-11P



B10CT-11F

Cookie/Pastry Cutter Set

- Rust-resistant stainless steel
- Available in various diameters and shapes for different molding needs
- Comes with a poly box for convenient storage and organization

Round Cutter Set

- Plain edge creates smooth round shape
- Fluted edge adds a charm of elegance and fun
- Each set can nest together for easy storage

Item	Description	UOM	Case
B10CT-11P	Plain Edge, 11-PC Set	Set	24
B10CT-11F	Fluted Edge, 11-PC Set	Set	24

Assorted-Shape Cutter Set

- Wide selection of shapes helps deliver personalized and customized messages



B11CT-6



B11CT-8



B11CT-12



B11CT-26

Item	Description	UOM	Case
B11CT-6	Holiday, 6-PC Set	Set	12/60
B11CT-8	Butterfly, 8-PC Set	Set	12/60
B11CT-12	Regular Shape, 12-PC Set	Set	12/60
B11CT-26	Letter, 26-PC Set	Set	12/48

Decorating Tip Set

- Stainless steel construction for excellent rust-resistance and enhanced durability
- Each set includes various tips that help create unique decorations.
- Every set is packed in a poly box with a clear top cover for easy picking and storage.
- Ideal for decorating and piping cakes, layered cakes, cupcakes, pastries and more

Item	Description	UOM	Case
B7DT-24	24-PC Set	Set	60
B7DT-26	26-PC Set	Set	12/48
B7DT-52	52-PC Set	Set	6/24



Coupler Set

- Durable construction fastens decorating tip in place during operation.

Item	Description	UOM	Case
B8PC-2	2-PC, Plastic	Set	12/360

B7DT-52



Polyurethane-Lined Cotton Pastry Bag

- Non-stick PU-lined interior for easy dispensing
- Cotton exterior offers a secure grip during operation with enhanced durability.
- Eco-friendly reusable solution in canvas style great for versatile piping needs
- Hanging loop included; hand wash recommended

Item	Description	UOM	Case
B14PB-12	12"	Each	12/576
B14PB-14	14"	Each	12/576
B14PB-16	16"	Each	12/576
B14PB-18	18"	Each	12/576
B14PB-21	21"	Each	12/576
B14PB-24	24"	Each	12/288



B14PB Series

Revolving Cake Stand

- Heavyweight cast iron base for added stability during operation
- Durable aluminum rolling plate with smooth rolling mechanism provides full and easy access to the cake on top.
- Non-slip silicone base adds extra stability while avoiding scratch.
- Ideal for both preparation and display

Item	Description	UOM	Case
B9CK-12AL	12"Dia	Each	6



B9CK-12AL

Cake Stand & Cover

- Minimal assembly required for cake stand

Item	Description	UOM	Case
SCKS-13	13"Dia Cake Stand, S/S	Each	6/12
DCSC-13	Cover for SCKS Series, NSF	Each	6



SCKS-13

DCSC-13



Pastry Brush

- Boar bristle perfect for coating, basting, and more
- Durable and water-resistant ABS ferrule helps to avoid shedding.
- Hardwood handle with hanging hole for easy storage

Item	Description	UOM	Case
WPPB-10	1" Bristle Width	Each	12/144
WPPB-15	1-1/2" Bristle Width	Each	12/144
WPPB-20	2" Bristle Width	Each	12/144
WPPB-30	3" Bristle Width	Each	12/72
WPPB-40	4" Bristle Width	Each	12/72



WPPB-10

WPPB-20

WPPB-40



B6SV-14

Stainless Steel Sieve

- Durable stainless steel body with hanging hook for lasting performance and convenient storage
- #20 mesh ideal for flour sifting and fine straining
- 3"H

Item	Description	UOM	Case
B6SV-10	10" Dia	Each	6
B6SV-12	12" Dia	Each	6
B6SV-14	14" Dia	Each	6
B6SV-16	16" Dia	Each	6



KUSN-8

Bouillon/Chinois Strainer

- Extra-fine mesh for smoother results
- Stainless steel construction for added durability
- Sturdy handle and front clip help with convenient operation.



KUSN-10X

Item	Description	UOM	Case
KUSN-8	8"	Each	12
KUSN-8X	8", Reinforced	Each	12
KUSN-10	10"	Each	12
KUSN-10X	10", Reinforced	Each	12



ALMC Series

Aluminum Measuring Cup

- Seamless and durable aluminum body, ideal for wet and dry measuring

Item	Description	UOM	Case
ALMC-05	0.5QT	Each	1/48
ALMC-10	1QT	Each	1/36
ALMC-20	2QT	Each	1/24
ALMC-40	4QT	Each	1/12



MCBK Series

Polycarbonate Measuring Cup

- Food grade polycarbonate cups with molded-in thumb-grip handle
- Dual-color embossed graduation in both Metric and Imperial unit marks
- Chipping- and temperature-resistant
- NSF listed; dishwasher safe



Item	Description	UOM	Case
MCBK-25	1 Cup/25-250ML	Each	6/72
MCBK-50	1PT/50-500ML	Each	6/72
MCBK-100	1QT/100-1000ML	Each	6/36
MCBK-200	2QT/200-2000ML	Each	6/36
MCBK-400	4QT/400-4000ML	Each	6/24
MCBK-5SET	5-Piece Set	Set	1/6



MSSI-4SET

MSS2-4

Measuring Spoon

- Stainless steel
- Each set includes one 1/4 tsp, one 1/2 tsp, one 1 tsp, and one 1 tbsp.

Item	Description	UOM	Case
MSSI-4SET	4-PC, Heavyweight	Set	24/240
MSS2-4	4-PC	Set	24/288

Oven Mitt

- Heat resistant kitchen helper ideal for heat/cold applications
- One size fits most; ambidextrous

Silicone-Coated Oven Mitt

- Non-stick coated cotton
- Heat resistant up to 200°F/94°C

Item	Description	UOM	Case
OMS1-13	13"	Each	12/72
OMS1-15	15"	Each	12/72
OMS1-17	17"	Each	12/72



Flame Retardant Oven Mitt

- 100% cotton
- Heat resistant up to 400°F/205°C

Item	Description	UOM	Case
OMF2-13F	13"	Each	12/72
OMF2-15F	15"	Each	12/72
OMF2-17F	17"	Each	12/72
OMF2-24F	24", Extra Length	Each	12/72



Terry Cloth Oven Mitt

- Silicone lining; 100% cotton
- Heat resistant up to 600°F/315°C

Item	Description	UOM	Case
OMS3-13T	13"	Each	12/72
OMS3-17T	17"	Each	12/72



Silicone Scraper

- Heat resistant; withstands temperatures up to 500°F/260°C
- BPA free



Item	Description	UOM	Case
KUSF-S-10	Flat Blade, 10"	Each	12/120
KUSF-S-14	Flat Blade, 14"	Each	12/120
KUSF-S-16	Flat Blade, 16-1/4"	Each	12/120
KUSB-S-10	Spoon Blade, 10"	Each	12/120
KUSB-S-14	Spoon Blade, 14"	Each	12/120
KUSB-S-16	Spoon Blade, 16-1/4"	Each	12/120



Rubber Scraper

- BPA free



Item	Description	UOM	Case
KUSF-R-10	Flat Blade, 10"	Each	24/360
KUSF-R-14	Flat Blade, 14"	Each	12/288
KUSF-R-16	Flat Blade, 16-1/4"	Each	12/288
KUSB-R-10	Spoon Blade, 10"	Each	12/120
KUSB-R-14	Spoon Blade, 14"	Each	12/72
KUSB-R-16	Spoon Blade, 16-1/4"	Each	12/36





SCPS-514

Stainless Steel Dough Scraper

- Flexible blade and round handle for easy control and firm grip
- Versatile aid great for cutting and scraping dough and transferring ingredients from one to another, e.g., flat surface to container

Item	Description	UOM	Case
SCPS-514	5-1/4" x 4-1/4"	Each	12/48



SCPD-5

SCPD-7

Dough Scraper

- NSF listed; BPA free



Item	Description	Size	UOM	Case
SCPD-5	-	5-1/2" x 3-3/4"	Doz	21/42
SCPD-7	6-PC/Pack	7-1/2" x 4-3/4"	Pack	24/48



DBPA-8 & DBPA-8C

Dough Pan

- Durable aluminum construction with rolled edge for bend resistance
- Stackable for space saving while proofing or storing dough
- Matching cover allows for a secure closure.

Item	Description	UOM	Case
DBPA-8	8-1/8" Dia, 48oz	Each	12/24
DBPA-8C	Cover for DBPA-8	Each	120
DBPA-9	9" Dia, 96oz	Each	12/24
DBPA-9C	Cover for DBPA-9	Each	120



DBBK-6H

Dough Box

- Made of heavy-duty polypropylene with reinforced sides and bottom for added durability
- Ideal for stacking and proofing
- NSF listed; BPA free



Item	Description	UOM	Case
DBBK-3H	25-5/8"L x 18"W x 3-1/4"H, NSF	Each	6
DBBK-6H	25-1/2"L x 17-1/2"W x 6"H, NSF	Each	3
DBCV-36H	Cover for DBBK Series	Each	12



DBCV-36H



Seamless Stacking and Proofing

Acrylic Display Case



- Made of crystal-clear acrylic for enhanced clarity and excellent visibility
- Durable acrylic construction with extra strength for long-lasting performance; non-slip rubber feet for steady countertop service
- Removable, slightly-tilted sliding trays and hinged rear door with magnetic closure for convenient loading/unloading
- Self-serve (ACDC-2 & ACDC-4): front door enables easy access for customers; hinged door closes downwards by itself to keep freshness and protect bakeries from dust and splash.
- Scratch-resistant and easy-to-clean interior and exterior for easy maintenance; hand wash recommended
- Ideal to display pastries, bagels, cookies and more for bakeries, coffee shops, convenient stores, diners, etc.
- Trays included; extra trays available for purchase
- Light assembly required
- BPA free

Item	Description	UOM	Case
ACDC-2	2-Tier, Front/Rear Doors	Set	1
ACDC-3	3-Tier, Rear Door	Set	1
ACDC-4	4-Tier, Front/Rear Doors	Set	1
ACDC-TY	Tray for ACDC Series	Each	12

SPECIFICATIONS

	ACDC-2	ACDC-3	ACDC-4
Dimensions (Fully Assembled)	21"L x 18"W x 12"H	21"L x 18"W x 16-1/2"H	14-1/8"L x 26-1/2"W x 24-1/2"H
Shipping Dimensions	28-3/8" x 19-5/8" x 5-1/2"H	22-1/2" x 20-1/2" x 7-1/2"H	28-3/4" x 28-3/8" x 6-3/4"H
Shipping Weight	18.0lbs	23.0lbs	35.0lbs



ACDC-4



ACDC-4



ACDC-TY



ACDC-3



ACDC-3



ACDC-2



ACDC-2

*Contents not included



APZR-987



APZR-987 in use with Pizza Screen
*Contents not included

Pizza Stand

- Saves space on dining table or counter by lifting up pizza pan or screen
- Durable metal body with a contemporary appearance
- Non-slip sleeves sturdily hold pizza pan during service.
- Simple yet versatile stand ideal for serving and displaying pizza, desserts, appetizers and more

Item	Description	UOM	Case
APZR-987	9" x 8" x 7"	Each	20



APZR-15

*Contents not included

Pizza Rack

- Sturdy and rust-resistant metal construction with heavy-duty rod
- Tiers tilted slightly backward, enhancing balance for sturdy service
- Great space saver with open access to all 15 tiers; each tier withstands up to 6.6 lbs.
- Ideal to hold and organize large batches of baking supplies such as pizza pans, sheet pans, and more
- Shelf spacing: 1-3/4"
- Ships welded; no assembly required

Item	Description	UOM	Case
APZR-15	15-Tier, 12-1/8"L x 12-1/8"W x 27-1/4"H	Each	2



Enhanced Balance: Tiers Tilted Slightly Backward

Wide Rim Pizza Pan

- Wide rim for easy and secure transporting during baking or serving
- NSF listed



Item	Description	UOM	Case
APZP-07W	7"	Each	36/72
APZP-08W	8"	Each	36/144
APZP-09W	9"	Each	36/72
APZP-10W	10"	Each	36/72
APZP-11W	11"	Each	36/72
APZP-12W	12"	Each	36/72
APZP-13W	13"	Each	36/72
APZP-14W	14"	Each	24/48
APZP-15W	15"	Each	24/48
APZP-16W	16"	Each	24/48
APZP-17W	17"	Each	12/36
APZP-18W	18"	Each	12/36
APZP-19W	19"	Each	12/24
APZP-20W	20"	Each	12/24



APZP Wide Rim Series

Coupe Pizza Pan

- Coupe design improves efficiency by allowing for baking, slicing, and serving on the same pan.
- Perfect for oven to table
- NSF listed



Item	Description	UOM	Case
APZP-08C	8"	Each	36/144
APZP-09C	9"	Each	36/144
APZP-10C	10"	Each	36/72
APZP-11C	11"	Each	36/72
APZP-12C	12"	Each	36/72
APZP-13C	13"	Each	36/72
APZP-14C	14"	Each	24/48
APZP-15C	15"	Each	24/48
APZP-16C	16"	Each	24/48
APZP-18C	18"	Each	12/36



APZP Coupe Series

Pizza Screen with Seamless Rim

- Great helper to ensure even heat distribution and promote air circulation.
- Seamless rim improves kitchen safety from rough or bent edges.

Item	Description	UOM	Case
APZS-07S	7"	Each	12/120
APZS-08S	8"	Each	12/120
APZS-09S	9"	Each	12/120
APZS-10S	10"	Each	12/120
APZS-11S	11"	Each	12/120
APZS-12S	12"	Each	12/120
APZS-13S	13"	Each	12/120
APZS-14S	14"	Each	12/120
APZS-15S	15"	Each	12/120
APZS-16S	16"	Each	12/120
APZS-17S	17"	Each	12/120
APZS-18S	18"	Each	12/60
APZS-19S	19"	Each	12/60
APZS-20S	20"	Each	12/60



APZS Series

Schnell Forged Cutlery

Crafting with precision and high quality in mind, C.A.C. pride ourselves on introducing Schnell®, an exceptional German steel cutlery series for superior performance, to the market. With ultra sharp blade and ergonomic handle, Schnell® helps you effortlessly conquer various cutting tasks in the kitchen.

- Forged full tang design
- High-carbon X50 Cr Mo V15 German steel
- Ice-tempered edge ensures every cut is clean and even.
- Finely designed edge angle ensures a perfect balance between sharpness and durability.
- Triple riveted POM handle in ergonomic shape offers exceptional balance and comfortable grip.
- Rapid sharpening and easy maintenance



Schnell Chef Knife 📦

Item	Description	Blade	UOM	Case
KFCC-G60	Chef Knife	6-1/4"	Each	6/36
KFCC-G80	Chef Knife	8"	Each	6/36
KFCC-G81	Chef Knife, Granton Edge	8"	Each	6/36
KFCC-G82	Chef Knife, Short Bolster	8"	Each	6/36
KFCC-G100	Chef Knife	10"	Each	6/36
KFCC-G101	Chef Knife, Granton Edge	10"	Each	6/36
KFCC-G102	Chef Knife, Short Bolster	10"	Each	6/36
KFCC-G120	Chef Knife	12"	Each	6/36



KFCC-G60



KFCC-G80



KFCC-G81



KFCC-G82



KFCC-G100



KFCC-G101



KFCC-G102



KFCC-G120

Schnell Utility Knife 🛒

Item	Description	Blade	UOM	Case
KFPE-G30	Peeling Knife	2-3/4"	Each	6/72
KFPC-G35	Paring Knife	3-1/2"	Each	6/72
KFUC-G50	Utility Knife	5"	Each	6/72
KFTM-G51	Tomato Knife	5"	Each	6/72
KFBN-G60	Boning Knife	6-3/8"	Each	6/36



Schnell Specialty Knife 🛒

Item	Description	Blade	UOM	Case
KFST-G71	Santoku Knife, Granton Edge	7-1/4"	Each	6/36
KFNK-G72	Nakiri Knife, Granton Edge	7-1/4"	Each	6/36
KFFL-G70	Fillet Knife, Flexible Blade	7-1/4"	Each	6/36
KFBR-G80	Bread Knife	8"	Each	6/36
KFCV-G80	Carving Knife	8"	Each	6/36
KFBR-G81	Bread Knife, Offset	8-3/8"	Each	6/36
KFCV-G101	Carving Knife, Granton Edge	10"	Each	6/36
KFSL-G101	Slicing Knife, Granton Edge	10"	Each	6/36

HIGH CARBON · NO STAIN
GERMAN STEEL
X 15 Cr Mo V





Klinge Stamped Cutlery

- German high-carbon steel
- Razor-sharp blade
- Non-slip handle with finger protective grip
- Rapid sharpening and easy maintenance

Item	Description	Blade	UOM	Case
KSPC-30	Paring Knife	3-1/4"	Each	6/36
KSUC-50	Utility Knife	5"	Each	6/36
KSBN-60	Boning Knife	6"	Each	6/36
KSBN-61	Boning Knife, Curved	6"	Each	6/36
KSBR-91	Bread Knife, Offset	9"	Each	6/36
KSBR-100	Bread Knife	10"	Each	6/36
KSCC-80	Chef Knife	8"	Each	6/36
KSCC-100	Chef Knife	10"	Each	6/36
KSSK-101	Cimeter Steak Knife	10"	Each	6/36
KSRB-120	Roast Beef Slicer	12"	Each	6/36



Schärfe Forged Cutlery

- Premium high-carbon steel
- Forged full tang design
- Ice-tempered blade featuring superior sharpness
- Rapid sharpening and easy maintenance

Item	Description	Blade	UOM	Case
KFPC-35	Paring Knife	3-1/2"	Each	6/72
KFUC-50	Utility Knife	5"	Each	6/72
KFBN-60	Boning Knife	6"	Each	6/36
KFBN-61	Boning Knife, Curved	6"	Each	6/36
KFBR-75	Bread Knife, Offset	7-1/2"	Each	6/36
KFBR-100	Bread Knife	10"	Each	6/36
KFCC-85	Chef Knife	8-1/2"	Each	6/36
KFCC-100	Chef Knife	10"	Each	6/36



KFPC-35



KFUC-50



KFBN-60



KFBN-61



KFBR-75



KFBR-100



KFCC-85



KFCC-100





KACH-70



Asian Cleaver

- Premium high-carbon steel
- Forged full tang design
- Heavy-duty construction
- Rapid sharpening and easy maintenance

Item	Description	Blade	UOM	Case
KACH-70	Asian Cleaver	7"	Each	6/24



KPHD-3



KWOC-234



KWOC-278



KWOC-312

Paring Knife with Plastic Handle

- Compact tool with short blade allows for precise, easy use for various tasks such as cutting, slicing and peeling.

Item	Description	Blade	UOM	Case
KPHD-3	Pointed Tip, White	3"	Each	12/360

Oyster/Clam Knife with Wooden Handle

- Handy tool for opening shellfish such as oyster, clam, mussel, scallop and more

Item	Description	Blade	UOM	Case
KWOC-234	Pointed Tip	2-3/4"	Each	12/72
KWOC-278	Pointed Tip	2-7/8"	Each	12/72
KWOC-312	Round Tip	3-1/2"	Each	12/72

Cut-Resistant Glove

- Reduces cut risk to help ensure safe and efficient operations
- Ambidextrous to fit both hands
- Machine washable



Use with caution.
Cut-resistant glove is NOT cut proof.



GLCR-9S

GLCR-9M

GLCR-9L

Stainless Steel Mesh Glove

- 304L rust-resistant stainless steel rings
- Full hand coverage for optimal cut protection
- Color-coded adjustable strap
- ANSI/ISEA 105-2016 cut-resistant level A9



Item	Description	UOM	Case
GLCR-9S	Small, White Strap	Each	10/50
GLCR-9M	Medium, Red Strap	Each	10/50
GLCR-9L	Large, Blue Strap	Each	10/50



GLCR-5S

GLCR-5M

GLCR-5L

GLCR-5XL

Anti-Microbial Yarn Glove

- Made of anti-microbial yarn for enhanced sanitation
- Complies with 21 CFR parts 170-199 for food contact
- ANSI/ISEA 105-2016 cut-resistant level A5



Item	Description	UOM	Case
GLCR-5S	Small, Red Wristband	Each	12/120
GLCR-5M	Medium, Green Wristband	Each	12/120
GLCR-5L	Large, Gray Wristband	Each	12/120
GLCR-5XL	Extra Large, Black Wristband	Each	12/120

HACCP Color-Coded Cutting Board



- Non-porous, non-absorbent surface
- Odor resistant
- Will not crack, splinter or expand
- Tough surface reduces knife dulling.
- Lightweight and easy-to-clean
- Reversible to extend life
- NSF listed; BPA free; dishwasher safe



CBPH Series

Item	Description	Color	UOM	Case
CBPH-0610W	10" x 6" x 1/2"	White	Each	20
CBPH-1218W	18" x 12" x 1/2"	White	Each	6
CBPH-1520W	20" x 15" x 1/2"	White	Each	6
CBPH-1824W	24" x 18" x 1/2"	White	Each	6
CBPH-1830W	30" x 18" x 1/2"	White	Each	6
CBPH-1218R	18" x 12" x 1/2"	Red	Each	6
CBPH-1218Y	18" x 12" x 1/2"	Yellow	Each	6
CBPH-1218G	18" x 12" x 1/2"	Green	Each	6
CBPH-1218BN	18" x 12" x 1/2"	Brown	Each	6
CBPH-1218BL	18" x 12" x 1/2"	Blue	Each	6
CBPH-1520R	20" x 15" x 1/2"	Red	Each	6
CBPH-1520Y	20" x 15" x 1/2"	Yellow	Each	6
CBPH-1520G	20" x 15" x 1/2"	Green	Each	6
CBPH-1520BN	20" x 15" x 1/2"	Brown	Each	6
CBPH-1520BL	20" x 15" x 1/2"	Blue	Each	6
CBPH-1824R	24" x 18" x 1/2"	Red	Each	6
CBPH-1824Y	24" x 18" x 1/2"	Yellow	Each	6
CBPH-1824G	24" x 18" x 1/2"	Green	Each	6
CBPH-1824BN	24" x 18" x 1/2"	Brown	Each	6
CBPH-1824BL	24" x 18" x 1/2"	Blue	Each	6

HACCP Color Coding System

	Raw Meats		Bakery and Dairy
	Raw Poultry		Cooked Meats
	Fruit and Vegetable		Fish and Seafood

Cutting Board Rack

- Heavy-duty chrome-plated steel construction for added strength and long-lasting performance
- 6 open slots hold and organize cutting boards up to 1" in thickness.
- Non-slip rubber feet designed for sturdy holding and protecting countertop surface from scratch
- Compact and durable solution for managing counter space

Item	Description	UOM	Case
CBRK-6S	6-Slot	Each	6/12



CBRK-6S
*Contents not included

Color-Coded Cutting Board Brush

- Durable poly body and bristle
- Ideal for working on textured cutting board surface
- Ergonomic shape and slip-resistant body for easy grip and operation
- Color-coded to help prevent cross-contamination

Item	Description	UOM	Case
CBPB-1W	White	Each	24/96
CBPB-1BN	Brown	Each	24/96
CBPB-1BL	Blue	Each	24/96
CBPB-1G	Green	Each	24/96
CBPB-1R	Red	Each	24/96
CBPB-1Y	Yellow	Each	24/96



Easy Grip and Slip Resistant



Durable Bristle



CBPB-1W

CBPB-1G

CBPB-1BN

CBPB-1R

CBPB-1BL

CBPB-1Y

Stainless Steel Disher

- Convenient and accurate portion control tool
- Durable 18/8 stainless steel construction
- Versatile portioning tool ideal for a wide variety of ingredients



Thumb Disher

- Color-coded handle for easy identification and enhanced sanitation
- NSF listed



Item	Description	Size	Color	UOM	Case
SICD-6WT	5oz	#6	White	Each	1/36
SICD-8GY	4oz	#8	Gray	Each	1/36
SICD-10IV	3.2oz	#10	Ivory	Each	1/36
SICD-12GN	2.66oz	#12	Green	Each	1/36
SICD-16BL	2oz	#16	Royal Blue	Each	1/36
SICD-20YL	1.6oz	#20	Yellow	Each	1/36
SICD-24RD	1.3oz	#24	Red	Each	1/36
SICD-30BK	1oz	#30	Black	Each	1/36
SICD-40OD	0.72oz	#40	Orchid	Each	1/36

Squeeze Disher

- Ambidextrous and easy to use with right or left hand



SICD Squeeze Disher Series

Item	Description	Size	UOM	Case
SICD-8S	4oz	#8	Each	1/48
SICD-10S	3.2oz	#10	Each	1/48
SICD-12S	2.8oz	#12	Each	1/48
SICD-16S	2oz	#16	Each	1/48
SICD-20S	1.66oz	#20	Each	1/48
SICD-24S	1.3oz	#24	Each	1/48
SICD-30S	1.25oz	#30	Each	1/48
SICD-40S	0.88oz	#40	Each	1/48
SICD-50S	0.63oz	#50	Each	1/48
SICD-60S	0.56oz	#60	Each	1/48
SICD-70S	0.48oz	#70	Each	1/48
SICD-100S	0.38oz	#100	Each	1/48



Ice Cream Scoop

- Heat-conductive handle for easy dipping
- Corrosion-resistant aluminum alloy construction

Item	Description	Size	UOM	Case
AICS-24	1.5oz	#24	Each	12/144
AICS-20	2oz	#20	Each	12/144
AICS-16	2.5oz	#16	Each	12/144
AICS-12	3oz	#12	Each	12/144



Ice Cream Spade

- One-piece stainless steel construction

Item	Description	UOM	Case
SICS-1	Ice Cream Spade	Each	12/120

ComfyGrip Kitchen Tool

C.A.C. ComfyGrip Kitchen Tool Series is constructed of high-carbon stainless steel for long-lasting performance and is designed with ergonomic soft-touch handle for comfortable and secure grip. Each tool features its own functionality to meet diverse needs in a busy kitchen.

Kitchen Tool

- High-carbon stainless steel
- Comfortable soft-touch handle
- Simple one-hand operation
- Convenient hanging hole
- Dishwasher safe

Item	Description	Length	UOM	Case
KTCG-TC01	Tomato Stem Corer	6-1/4"	Each	12/72
KTCG-AC02	Apple Corer	8-1/4"	Each	12/72
KTCG-MB03	Mellon Baller	6-7/8"	Each	12/72
KTCG-CP04	Cheese Plane	8-5/8"	Each	12/72
KTCG-PS05	Straight Peeler	7-1/2"	Each	12/72
KTCG-PS06	Straight Peeler, Serrated	7-1/2"	Each	12/72
KTCG-PY07	Straight "Y" Peeler	5-3/4"	Each	24/72
KTCG-PY08	Straight "Y" Peeler, Serrated	5-3/4"	Each	24/72
KTCG-GM09	Grater, Medium	9-5/8"	Each	12/72
KTCG-OK10	Oyster Knife	7-1/4"	Each	12/72



High-Carbon Stainless Steel



Soft-Touch Handle

Can Opener

Available in turning knob and crank handle, C.A.C. ComfyGrip Can Opener Series opens #10 cans fast and easily with gear-driven mechanism. Designed with heavy-gauge, chrome-steel body and ultra comfortable rubberized handle, C.A.C. ComfyGrip Can Opener Series is able to stand up to tough tasks with lasting performance while providing high level of comfort during operation.

- Flexural, fatigue-resistant grip
- High impact strength construction
- Gear-operated rotary blade
- Built-in bottle opener/cap remover
- Dishwasher safe

Item	Description	Length	UOM	Case
COCG-TK01	Turning Knob	7"	Each	12/48
COCG-CH02	Crank Handle	8-3/4"	Each	12/48



COCG-TK01



COCG-CH02



KTCG-TC01



KTCG-AC02



KTCG-MB03



KTCG-CP04



KTCG-PS05



KTCG-PS06



KTCG-PY07



KTCG-PY08



KTCG-GM09



KTCG-OK10



Portion Spoon with Black Handle

- One-piece stainless steel construction
- Black handle with finger hook for secure and comfortable grip

Item	Description	UOM	Case
SPCS-2K	2oz, Solid	Each	12/72
SPCS-3K	3oz, Solid	Each	12/72
SPCS-4K	4oz, Solid	Each	12/72
SPCS-6K	6oz, Solid	Each	12/72
SPCS-8K	8oz, Solid	Each	12/72
SPCP-2K	2oz, Perforated	Each	12/72
SPCP-3K	3oz, Perforated	Each	12/72
SPCP-4K	4oz, Perforated	Each	12/72
SPCP-6K	6oz, Perforated	Each	12/72
SPCP-8K	8oz, Perforated	Each	12/72



Portion Spoon with Color-Coded Handle

- One-piece stainless steel construction
- Color-coded handle with finger hook for easy recognition and comfortable grip

Item	Description	Color	UOM	Case
SPCT-2RD	2oz, Solid	Red	Each	12/72
SPCT-3IV	3oz, Solid	Ivory	Each	12/72
SPCT-4GN	4oz, Solid	Green	Each	12/72
SPCT-8BL	8oz, Solid	Blue	Each	12/72
SPCP-2RD	2oz, Perforated	Red	Each	12/72
SPCP-3IV	3oz, Perforated	Ivory	Each	12/72
SPCP-4GN	4oz, Perforated	Green	Each	12/72
SPCP-8BL	8oz, Perforated	Blue	Each	12/72



Basting Spoon

- One-piece stainless steel construction

Item	Description	Thickness	UOM	Case
SBHS-11	11", Solid	1.2mm	Each	12/144
SBHP-11	11", Perforated	1.2mm	Each	12/144
SBHL-11	11", Slotted	1.2mm	Each	12/144
SBHS-13	13", Solid	1.2mm	Each	12/144
SBHP-13	13", Perforated	1.2mm	Each	12/144
SBHL-13	13", Slotted	1.2mm	Each	12/144
SBHS-15	15", Solid	1.2mm	Each	12/144
SBHP-15	15", Perforated	1.2mm	Each	12/144
SBHL-15	15", Slotted	1.2mm	Each	12/144
SBSO-18	18", Solid	1.5mm	Each	12/72
SBSP-18	18", Perforated	1.5mm	Each	12/72
SBSO-21	21", Solid	1.5mm	Each	12/72
SBSP-21	21", Perforated	1.5mm	Each	12/72



Basting Spoon with Black Handle

- One-piece stainless steel construction
- Plastic handle with finger hook for secure and comfortable grip

Item	Description	Thickness	UOM	Case
SBSO-11BH	11" Solid	1.2mm	Each	12/72
SBSP-11BH	11" Perforated	1.2mm	Each	12/72
SBSL-11BH	11" Slotted	1.2mm	Each	12/72
SBSO-13BH	13" Solid	1.2mm	Each	12/72
SBSP-13BH	13" Perforated	1.2mm	Each	12/72
SBSL-13BH	13" Slotted	1.2mm	Each	12/72
SBSO-15BH	15" Solid	1.2mm	Each	12/72
SBSP-15BH	15" Perforated	1.2mm	Each	12/72
SBSL-15BH	15" Slotted	1.2mm	Each	12/72

Ladle

–One-piece stainless steel construction

Item	Description	Length	UOM	Case
SSLD-05	0.5oz	11-1/4"	Each	12/240
SSLD-10	1oz	11-1/4"	Each	12/240
SSLD-20	2oz	11-7/8"	Each	12/120
SSLD-30	3oz	12-5/8"	Each	12/120
SSLD-40	4oz	14"	Each	12/120
SSLD-60	6oz	14-3/8"	Each	12/120
SSLD-80	8oz	14-3/4"	Each	12/120
SSLD-120	12oz	15-1/8"	Each	12/120
SSLD-160	16oz	15-1/2"	Each	12/120



Ladle with Color-Coded Handle

–One-piece stainless steel construction
–Color-coded handle for easy recognition and portion control

Item	Description	Length	UOM	Case
SSLD-05GN	0.5oz, Green	11-3/8"	Each	12/120
SSLD-10BK	1oz, Black	11-1/2"	Each	12/120
SSLD-20BL	2oz, Blue	12"	Each	12/120
SSLD-30IV	3oz, Ivory	12-3/4"	Each	12/120
SSLD-40GY	4oz, Gray	14-1/8"	Each	12/120
SSLD-60TL	6oz, Teal	14-3/4"	Each	12/120
SSLD-80OR	8oz, Orange	14-7/8"	Each	12/60
SSLD-120RD	12oz, Red	13-3/8"	Each	12/60



SSLD Series

Ladle with Short Handle

–One-piece stainless steel construction
–Hooked handle for convenient use and storage

Item	Description	UOM	Case
SLD6-05	0.5oz, 6" Handle	Each	12/120
SLD6-10	1oz, 6" Handle	Each	12/120
SLD6-15	1.5oz, 6" Handle	Each	12/120
SLD6-20	2oz, 6" Handle	Each	12/120
SLD6-30	3oz, 6" Handle	Each	12/120
SLD6-40	4oz, 6" Handle	Each	12/120
SLD6-60	6oz, 6" Handle	Each	12/120



SLD6-05

SLD6-20

SLD6-60

Pasta Fork

–Constructed with stainless steel and long handle, great for serving

Item	Description	UOM	Case
PFKS-9	9"	Each	12/144
PFKS-11	11"	Each	12/144



PFKS-9

PFKS-11

Turner

–Durable stainless steel construction

Item	Description	UOM	Case
STNR-14S	14" Solid	Each	12/72
STNR-14L	14" Slotted	Each	12/72



STNR-14S

STNR-14L



Single-Layer Mesh

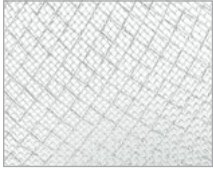

Double-Layer Mesh



SSTR-06S



SSTR-06D

Mesh Strainer

- Mesh, rim and handle frame are made of stainless steel, not tinned, for enhanced durability.
- Convenient hook allows for hand-free operation.

Item	Description	Size (Dia)	Handle	UOM	Case
SSTR-06S	Single-Layer	6-1/4"	Flat	Each	12/96
SSTR-08S	Single-Layer	8"	Flat	Each	12/48
SSTR-10S	Single-Layer	10-1/4"	Flat	Each	12/48
SSTR-11S	Single-Layer	11"	Flat	Each	12/24
SSTR-06D	Double-Layer	6-1/4"	Flat	Each	12/96
SSTR-08D	Double-Layer	8"	Flat	Each	12/48
SSTR-10D	Double-Layer	10-1/4"	Flat	Each	12/48
SSTR-11D	Double-Layer	11"	Flat	Each	12/24



STRH-10D

STRH-12D

Reinforced Mesh Strainer

- Designed with reinforcing bands, ideal for heavy-duty applications
- Mesh, rim and handle frame are made of stainless steel, not tinned, for enhanced durability.

Item	Description	Size (Dia)	Handle	UOM	Case
STRH-10S	Single-Layer	10-1/4"	Flat	Each	12
STRH-10D	Double-Layer	10-1/4"	Flat	Each	12
STRH-12D	Double-Layer	12"	Round	Each	6
STRH-14D	Double-Layer	14"	Round	Each	6



SSTR-05S

Blanching Basket

- Hanger hook for easy operation and storage
- Built-on stainless steel clip makes it easily hung to cookware for safety and convenience.

Item	Description	UOM	Case
SSTR-05S	5-1/2" Dia	Each	12/48



KUSN-8

KUSN-10X

Bouillon/Chinois Strainer

- Extra-fine mesh for smoother results
- Stainless steel construction for added durability
- Sturdy handle and front clip help with convenient operation.

Item	Description	UOM	Case
KUSN-8	8"	Each	12
KUSN-8X	8", Reinforced	Each	12
KUSN-10	10"	Each	12
KUSN-10X	10", Reinforced	Each	12

Nickel-Plated Skimmer

- Nickel-plated metal construction
- Long handle for safe operation
- Ideal to lift food or skim unwanted debris
- Great for straining, blanching, filtering, lifting and more
- Hanging hole on handle for convenient storage
- Easy to clean



Sturdy Metal Construction



Hanging Hole

Mesh Skimmer

Item	Description	UOM	Case
SKMS-7S	7", Square	Each	12/48
SKMS-7R	6-1/2" Dia, Round	Each	12/48



SKMS-7S



SKMS-7R

Wire Skimmer

Item	Description	UOM	Case
SKWR-5	5" Dia	Each	12/36
SKWR-6	6" Dia	Each	12/36
SKWR-7	7" Dia	Each	12/36
SKWR-8	8" Dia	Each	12/24
SKWR-9	9" Dia	Each	12/24
SKWR-12	12" Dia	Each	12/24



SKWR-9

Spiral Skimmer

- Spiral wire design works great with solid seasonings in relatively bigger sizes

Item	Description	UOM	Case
SKSP-07	7" Dia	Each	12/48
SKSP-09	9" Dia	Each	12/48



SKSP-09

Stainless Steel Skimmer

- Durable stainless steel construction

Item	Description	UOM	Case
SSKM-45	4-1/2" Dia	Each	12/120
SSKM-60	6" Dia	Each	12/120



SSKM-45



SFNW-6



SFNW-ST

Stainless Steel Funnel

- Made of dent-, corrosion- and rust-resistant stainless steel
- Quick and easy operation
- Strainer available for purchase separately

Item	Description	UOM	Case
SFNW-5	5"Dia 10oz	Each	12/72
SFNW-6	5-3/4"Dia 16oz	Each	12/72
SFNW-ST	Strainer for Funnel SFNW-5/6	Each	120/480



SFNP-16W

Funnel

- Tear- and wear-resistant polyethylene
- Great for transferring liquids and small ingredients with minimum spills

Item	Description	UOM	Case
SFNP-8W	4"Dia 8oz, White	Each	6/324
SFNP-16W	5-1/4"Dia 16oz, White	Each	6/324
SFNP-32W	6-1/4"Dia 32oz, White	Each	6/216



SSMP Series

Mixing Paddle

- Durable stainless steel construction ideal for heavy mixing
- Corrosion- and rust-resistant
- Standard size works well with large crock pots.
- Easy to clean and maintain

Item	Description	UOM	Case
SSMP-24	24"	Each	12
SSMP-36	36"	Each	12
SSMP-48	48"	Each	12
SSMP-60	60"	Each	12



SPWD Series

Wood Spoon

- Non-scratch natural wood
- One-piece construction
- 1/2" diameter handle
- Versatile spoon ideal for mixing and stirring dough, sauce, soup and more
- Individually packed in a poly bag with colored hang tag

Item	Description	UOM	Case
SPWD-12	12"	Doz	1/8
SPWD-14	14"	Doz	1/8
SPWD-16	16"	Doz	1/8
SPWD-18	18"	Doz	1/8



ALMT-1

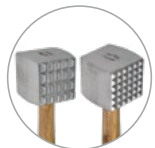

ALMT-2

Meat Tenderizer

- Heavy-duty aluminum construction
- Grooved side for tenderizing and flat side for pounding

Item	Description	UOM	Case
ALMT-1	2" x 2" x 9-1/2"L	Each	36
ALMT-2	3" x 2-1/2" x 12-3/4"L w/ Wooden Handle	Each	6/12

French Whip/Whisk

- Heavy-duty stainless steel construction with strong, center-reinforced and thick wires
- Fully-sealed connection between handle and wire for enhanced sanitation
- Ideal for blending, whipping, and beating heavy food products
- Works well with straight-sided or deep containers

Item	Description	UOM	Case
WPFR-10S	10"	Each	12/72
WPFR-12S	12"	Each	12/72
WPFR-14S	14"	Each	12/72
WPFR-16S	16"	Each	12/60
WPFR-18S	18"	Each	12/60
WPFR-20S	20"	Each	12/60
WPFR-22S	22"	Each	12/60
WPFR-24S	24"	Each	12/60

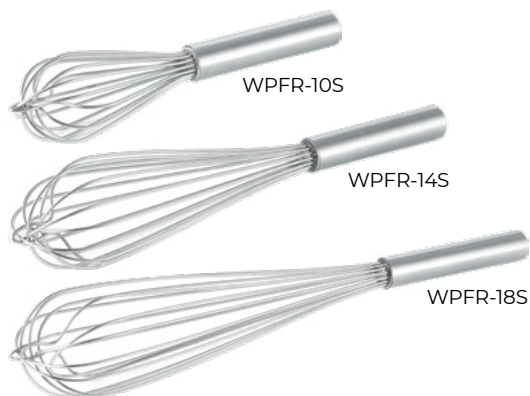

Piano Whip/Whisk

- Heavy-duty stainless steel construction with strong and center-reinforced wires
- Fully-sealed connection between handle and wire for enhanced sanitation
- Ideal for blending, whipping, and beating
- Flexible and springy wires with large end for added motion

Item	Description	UOM	Case
WPPA-10S	10"	Each	12/72
WPPA-12S	12"	Each	12/72
WPPA-14S	14"	Each	12/72
WPPA-16S	16"	Each	12/72
WPPA-18S	18"	Each	12/72

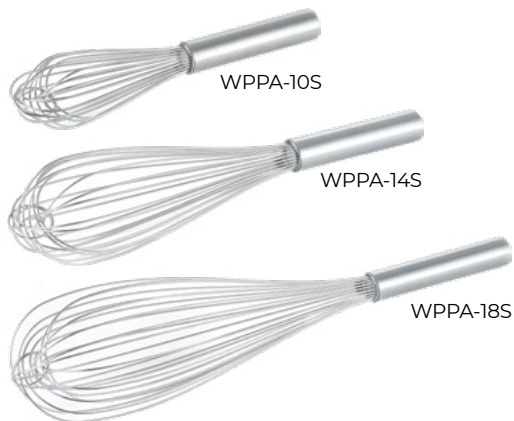

Nylon Utensil

- Nylon material helps protect non-stick surface.
- Non-slip handle for a secure and comfortable grip
- Heat resistant up to 410°F/210°C
- Functional tools satisfy various kitchen tasks.
- BPA free



Item	Description	UOM	Case
KUNL-SO01	Solid Spoon	Each	12/144
KUNL-SL02	Slotted Spoon	Each	12/144
KUNL-F203	2-Prong Fork	Each	12/144
KUNL-FP04	Pasta Fork	Each	12/144
KUNL-LD05	Ladle 5oz	Each	12/144
KUNL-TL06	Slotted Turner	Each	12/144
KUNL-SP07	Slotted Spatula	Each	12/144
KUNL-SK08	Skimmer	Each	12/144
KUNL-MS09	Masher	Each	12/144
KUNL-WP10	Whip	Each	12/144





SPRC-R

Potato Ricer

- Made of corrosion-resistant stainless steel
- Surrounding mesh on the side provides smooth results while reducing waste.
- Easy and effortless pressing and squeezing
- Dishwasher safe

Item	Description	UOM	Case
SPRC-R	Round	Each	1/6



SEGR Series

Egg Ring

- 1" deep stainless steel ring helps deliver consistent result.
- Multifunctional for cooking eggs, pancakes, burger patties and more
- Dishwasher safe; hanging hole for convenient storage

Item	Description	UOM	Case
SEGR-3	3" Dia	Each	12/144
SEGR-4	4" Dia	Each	12/144
SEGR-5	5" Dia	Each	12/144
SEGR-6	6" Dia	Each	12/96



SKSR Series

Skewer

- Made of stainless steel with a pointed tip for holding both small delicate foods and big chunks of food
- Round looped handle for easy handling
- Versatile for food preparing, cooking, grilling, serving and more

Item	Description	UOM	Case
SKSR-8	8", Round Looped Handle	Doz	5/100
SKSR-10	10", Round Looped Handle	Doz	5/60
SKSR-12	12", Round Looped Handle	Doz	5/60



ALSC-5

ALSC-85

Aluminum Scoop

- Aluminum construction with curved handle for enhanced durability and comfortable grip
- NSF listed; hand wash only



Item	Description	UOM	Case
ALSC-5	5oz	Each	12/60
ALSC-12	12oz	Each	12/60
ALSC-24	24oz	Each	12/60
ALSC-38	38oz	Each	12/48
ALSC-58	58oz	Each	12/36
ALSC-85	85oz	Each	12/24



SCPP-12

SCPP-64

Polycarbonate Scoop

- Break-resistant clear polycarbonate body
- NSF listed



Item	Description	UOM	Case
SCPP-6	6oz	Each	12/144
SCPP-12	12oz	Each	12/72
SCPP-24	24oz	Each	12/48
SCPP-32	32oz	Each	12/48
SCPP-64	64oz	Each	12/24

Pineapple Corer

- 304 stainless steel construction for exceptional corrosion-, rust- and acid-resistance; ultra-resilient handle ideal for high-volume commercial use
- Offers fast and easy peeling, coring, cutting and slicing
- Handles fresh pineapple all-in-one with consistent results
- Quick disassembly with built-on release button for easy cleaning, sanitizing and storage
- Protective plastic cap covers the sharp blade edge for enhanced safety.

Item	Description	UOM	Case
KTPC-10	9-7/8" L x 3-1/2" Dia	Each	1/24



KTPC-10

Apple Corer/Slicer

- Durable aluminum construction withstands daily busy use.
- Efficient coring and slicing with clean cut
- Duo ergonomic handles for safe and easy operation

Item	Description	UOM	Case
KTAC-12	4-3/4" Dia	Each	12/48



KTAC-12

Box Grater

- Durable stainless steel construction
- 4-sided design for great versatility
- Easy to clean and maintain

Item	Description	UOM	Case
SBGT-S	Straight	Each	12/24
SBGT-T	Tapered	Each	12/72



SBGT-S



SBGT-T

Spreader with Plastic Handle

- 3-7/8" serrated stainless steel blade
- Non-slip polypropylene handle for a secure and comfortable grasp

Item	Description	UOM	Case
SPSP-4WT	White	Each	12/144
SPSP-4BK	Black	Each	12/144
SPSP-4BL	Blue	Each	12/144
SPSP-4BN	Brown	Each	12/144
SPSP-4GN	Green	Each	12/144
SPSP-4RD	Red	Each	12/144
SPSP-4YL	Yellow	Each	12/144



SPSP Series

SPSW-4

Spreader with Wooden Handle

- 3-3/4" serrated stainless steel blade

Item	Description	UOM	Case
SPSW-4	Wooden Handle	Each	12/144



SCD1-22

Digital Portion Control Scale

- Removable stainless steel platform and durable ABS body
- LCD screen with back light for clear and convenient reading
- Conventional control panel with five buttons for easy operation
- Five weighing modes satisfy most weighing needs.
- Calibratable for prolonged accuracy in measurement
- Dual power by external adapter or 2 AA batters (included)

Item	Description	UOM	Case
SCD1-22	22LB Capacity	Each	6



ALTP-8

CITP-8

Tortilla Press

- Flatten and shape tortillas in one simple press
- Ideal for both corn and flour tortillas
- Smooth and ergonomic handle

Item	Description	UOM	Case
CITP-8	8"Dia, Cast Iron	Each	1/4
ALTP-8	8"Dia, Aluminum	Each	6/12



SWCI-20

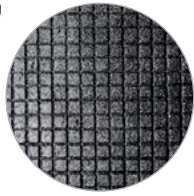

Textured Bottom

Steak Weight

- Cast iron base with wooden handle for enhanced durability and safety
- Great at transferring and retaining heat, allowing for efficient cooking
- Textured bottom leaves appealing grill marks while helping to avoid sliding.
- Ideal for pressing and flattening burger patties, steak, bacon and more

Item	Description	UOM	Case
SWCI-20	2lbs, 8-1/4" x 4-1/4"	Each	6
SWCI-25	2.5lbs, 9" x 5-1/4"	Each	6



ALCL-16SL



ALCL-16SH

Aluminum Colander

- Sturdy base and handles for easy draining and transporting
- Higher base for improved sanitation
- Ideal for high-volume commercial kitchen

Item	Description	Handle	UOM	Case
ALCL-08SH	8QT	Flat	Each	4
ALCL-12SH	12QT	Flat	Each	4
ALCL-16SH	16QT	Flat	Each	4
ALCL-12SL	12QT	Looped	Each	4
ALCL-16SL	16QT	Looped	Each	4



ALCL-16C



ALCL-16CH

Aluminum Chinese Colander

- Easier to clean without protruding base
- Ideal for high-volume commercial kitchen

Item	Description	Handle	UOM	Case
ALCL-12C	12QT	-	Each	12
ALCL-16C	16QT	-	Each	12
ALCL-16CH	16QT	Looped	Each	6

Stainless Steel Colander

- Made of durable and dent-resistant stainless steel
- Sturdy base and welded handles for easy draining and transporting
- Ideal for high-volume commercial kitchen

Item	Description	Size (Dia x H)	UOM	Case
SMCD-3	3QT	9-7/8" x 3-3/8"	Each	12/24
SMCD-5	5QT	11-5/8" x 3-7/8"	Each	12/24
SMCD-8	8QT	13-3/8" x 5-1/8"	Each	6/12
SMCD-13	13QT	16-1/4" x 4-3/4"	Each	12



SMCD Series



SCD5-L6



SCD3-S6

Stainless Steel Chinese Colander

- Made of durable and dent-resistant stainless steel
- Two size selections of draining hole to meet different tasks
- Ideal for high-volume commercial kitchen

Item	Description	Hole	UOM	Case
SCD5-L6	5.5QT	Large	Each	24
SCD3-S6	5.5QT	Small	Each	24
SCD5-L9	9QT	Large	Each	24
SCD3-S9	9QT	Small	Each	24
SCD5-L14	13.75QT	Large	Each	12
SCD3-S14	13.75QT	Small	Each	12

Heavy-Duty Mixing Bowl

- Constructed from quality stainless steel with added thickness for enhanced durability
- Stackable for efficient space consumption

Item	Description	Size (Dia x H)	UOM	Case
SMXB-7-75	0.75QT	6-1/4" x 1-7/8"	Each	12/72
SMXB-7-150	1.5QT	7-7/8" x 2-1/2"	Each	12/36
SMXB-7-300	3QT	9-3/4" x 3-1/4"	Each	12/24
SMXB-7-400	4QT	10-1/2" x 3-1/2"	Each	12/24
SMXB-7-500	5QT	11-5/8" x 3-5/8"	Each	6/12
SMXB-7-800	8QT	13-1/4" x 4"	Each	6/12
SMXB-7-1300	13QT	16-1/8" x 4-7/8"	Each	12
SMXB-7-1600	16QT	17-7/8" x 5-3/8"	Each	12
SMXB-7-2000	20QT	18-7/8" x 5-1/2"	Each	12



SMXB-7 Series

Economy Mixing Bowl

- Medium duty in lighter weight for easier handling in a busy commercial kitchen
- Stackable for efficient space consumption

Item	Description	Size (Dia x H)	UOM	Case
SMXB-4-75	0.75QT	6-1/4" x 1-5/8"	Each	12/144
SMXB-4-150	1.5QT	7-7/8" x 2-1/2"	Each	12/144
SMXB-4-300	3QT	9-7/8" x 3-1/4"	Each	12/72
SMXB-4-400	4QT	10-5/8" x 3-5/8"	Each	12/72
SMXB-4-500	5QT	11-5/8" x 3-7/8"	Each	12/72
SMXB-4-800	8QT	13-3/8" x 4"	Each	12/36
SMXB-4-1300	13QT	16-1/8" x 4-3/4"	Each	12/24
SMXB-4-1600	16QT	17-3/4" x 5-3/8"	Each	12
SMXB-4-2000	20QT	18-7/8" x 5-3/4"	Each	12
SMXB-4-3000	30QT	22-1/2" x 7-1/2"	Each	12



SMXB-4 Series

Utility Pail

- Sturdy stainless steel construction with wire handle for added strength and convenient carrying

Item	Description	Size (Dia x H)	UOM	Case
SUPL-13	13QT	10-1/4" x 11-3/4"	Each	12



SUPL-13



Built with wide temperature ranges and different specialty functions, C.A.C. EquilThermo® Thermometer Series is a must-have kitchen essential for food service facilities to help with food safety monitoring and food preparation.



Every EquilThermo® thermometer has a retail-ready packaging as shown above.



FPMT-P1



FPMT-P2



FPMT-P3



FPMT-F8



FPMT-IR9



FPMT-GF11



FPMT-M4



FPMT-M5

Dial Thermometer

- NSF listed



Item	Description	Temperature Range	Dial Size	Probe Length	Feature	UOM	Case
FPMT-P1	Pocket Test	0-220°F/-18-104°C	1"	5"	Protective Sleeve; Calibratable	Each	12/72
FPMT-P2	Pocket Test	-40-180°F/-40-80°C	1"	5"	Protective Sleeve; Calibratable	Each	12/72
FPMT-P3	Pocket Test	50-550°F/10-288°C	1"	5"	Protective Sleeve; Calibratable	Each	12/144
FPMT-M4	Meat	130-190°F/55-85°C	2"	5"	Adjustable Indicator	Each	12/144
FPMT-M5	Meat	130-190°F/55-85°C	3"	5"	Adjustable Indicator	Each	12/72
FPMT-OV6	Oven	40-500°F/10-260°C	2"	-	Top Hook; Reinforced Glass	Each	12/144
FPMT-OV7	Oven	40-500°F/10-260°C	3"	-	Top Hook; Reinforced Glass	Each	12/144
FPMT-F8	Frothing	0-220°F/-18-104°C	1"	5"	S/S Clip; Calibratable	Each	12/144
FPMT-IR9	Instant Read	0-220°F/-18-104°C	1-3/4"	5"	Protective Sleeve; Calibratable	Each	12/72
FPMT-GF11	Grill Top	150-700°F/70-370°C	2"	-	Side Handles; Reinforced Glass	Each	12/144
FPMT-DF12	Deep Fry/Candy	100-400°F/40-200°C	2"	5"	Adjustable Indicator; S/S Clip	Each	12/144
FPMT-DF13	Deep Fry/Candy	100-400°F/40-200°C	2"	12"	Adjustable Indicator; S/S Clip	Each	12/144
FPMT-DF15	Deep Fry/Candy	100-500°F/40-260°C	3"	12"	Adjustable Indicator; S/S Clip; Calibratable	Each	6/36
FPMT-RF17	Fridge/Freezer	-20-70°F/-30-21°C	2"	-	Top Hook; Base Stand	Each	12/72
FPMT-RF18	Fridge/Freezer	-20-70°F/-30-21°C	3"	-	Top Hook; Base Stand	Each	12/72



FPMT-DF12



FPMT-DF13



FPMT-DF15



FPMT-OV6



FPMT-OV7



FPMT-RF17



FPMT-RF18





Liquid-in-Glass Thermometer 🛒

- NSF listed: FPMT-RF16, FPMT-RF19



Item	Description	Temperature Range	Size	Feature	UOM	Case
FPMT-DF14	Deep Fry/Candy	100-400°F/40-200°C	2" x 12"	S/S Frame; Rectangular	Each	12/72
FPMT-RF16	Fridge/Freezer	-26-86°F/-30-30°C	2-7/8 x 5/8"	Suction Cup Included; 2-PC/Pack	Pack	12/144
FPMT-RF19	Fridge/Freezer	-20-80°F/-28-26°C	3-1/2" x 1-1/8"	S/S Mounts; Reinforced Glass	Each	12/72

Digital Thermometer 🛒

- NSF listed



Item	Description	Temperature Range	LCD Size	Probe Length	Feature	UOM	Case
FPMT-DG20	Instant Read	-40-302°F/-40-150°C	1"	4-3/4"	Protective Sleeve w/ Clip	Each	12/144
FPMT-DG21	Instant Read	-49-392°F/-45-200°C	1-1/4"	4-3/4"	180° Head Swivel; Protective Sleeve w/ Clip	Each	12/72
FPMT-DG22	Instant Read	-40-450°F/-40-230°C	1-1/4"	3-1/8"	Hold Function	Each	12/144
FPMT-DG23	Instant Read	-49-392°F/-45-200°C	1-3/8"	2-7/8"	Min/Max Memory; Hold Function; LCD w/ Back Light	Each	12/72
FPMT-RM10	Roast	-58-572°F/-50-300°C	1-7/8"	6"	Digital Alert; Countdown Timer	Set	24/96
FPMT-WF24	Waterproof	-58-392°F/-50-200°C	7/8"	2-3/4"	Auto Off; Hold Function	Each	24/96

Infrared Thermometer 🛒

Item	Description	Temperature Range	LCD Size	Feature	UOM	Case
FPMT-IF25	Infrared	-26-716°F/-32-380°C	1"	Non-Contact Measurement; High Accuracy and Fast Response; LCD w/ Back Light	Each	12/48



Kitchen Equipment

C.A.C. Kitchen Equipment Series features a wide selection of food processing equipment to help cut down on preparation time in any busy kitchens. Designed for convenient use, safety and durability, C.A.C. Kitchen Equipment Series is built to stand up to the rigors of daily tasks and deliver consistent results with improved efficiency.



FPHP-Series

Heavy-Duty Burger Patty Molding Press

- Handy portion control and molding tool for precise and consistent results every time
- Heavy-duty stainless steel bowl and aluminum base in a compact size with ergonomic handle
- ETL Sanitation listed; complies with NSF-2



Item	Description	UOM	Case
FPHP-4	4" Dia, 1/4LB of Meat	Set	1
FPHP-5	6" Dia, 1/2LB of Meat	Set	1



FPJC-23RD

Countertop Juice Squeezer 🛒

- 3-pinion powerful squeezing exerts up to 265 lbs of pressure.
- Extra height 23-1/4" with maximum height of 34-5/8" fits containers up to 11-3/4" tall.
- Heavy-duty construction includes durable, corrosion-resistant stainless steel strainer parts and sturdy cast iron frame with acid-resistant finish.
- Non-skid rubber feet for stable operation; removable strainer parts for easy cleaning

Item	Description	UOM	Case
FPJC-23GY	Gray	Set	1/2
FPJC-23RD	Red	Set	1/2



FPJC-23GY



Extra Height



Removable Strainer Parts

Vegetable Dicer

- 3-1/4" x 3-1/4" push block
- Sturdy cast aluminum body with non-slip rubber feet
- Razor-sharp stainless steel blade for smooth cutting and consistent results
- T-shaped handle ensures a comfortable grip and effortless operation.

Item	Description	UOM	Case
FPDC-500S	1/2", Dicer	Set	1
FPDC-375S	3/8", Dicer	Set	1
FPDC-250S	1/4", Dicer	Set	1
FPDC-500SBDS	1/2" Blade Assembly	Set	24
FPDC-375SBDS	3/8" Blade Assembly	Set	24
FPDC-250SBDS	1/4" Blade Assembly	Set	24
FPDC-500SBD	1/2" Blade Only	Each	12/24
FPDC-375SBD	3/8" Blade Only	Each	12/24
FPDC-250SBD	1/4" Blade Only	Each	12/24
FPDC-2500SPB	1/4" and 1/2" Push Block	Each	12/48
FPDC-375SPB	3/8" Push Block	Each	12/48
FPDC-BMP	Replacement Bumper, 2-PC/Pack	Pack	24/144
FPDC-FET	Replacement Feet, 4-PC/Pack	Pack	12/72
FPDC-SCR	Replacement Thumb Screw	Each	100
FPDC-BSH	Replacement Bushing, 4-PC/Pack	Pack	24



FPDC-375S



FPDC-500SBDS



FPDC-375SBDS



FPDC-250SBDS



FPDC-BMP



FPDC-FET



FPDC-SCR



FPDC-BSH

Large Vegetable Dicer

- 4" x 4" push block
- Sturdy cast aluminum body with non-slip rubber feet
- Razor-sharp stainless steel blade for smooth cutting and consistent results
- T-shaped handle ensures a comfortable grip and effortless operation.

Item	Description	UOM	Case
FPDC-500L	1/2", Large Dicer	Set	1
FPDC-375L	3/8", Large Dicer	Set	1
FPDC-250L	1/4", Large Dicer	Set	1
FPDC-500LBDS	1/2" Blade Assembly	Set	24
FPDC-375LBDS	3/8" Blade Assembly	Set	24
FPDC-250LBDS	1/4" Blade Assembly	Set	24
FPDC-500LBD	1/2" Blade Only	Each	24
FPDC-375LBD	3/8" Blade Only	Each	24
FPDC-250LBD	1/4" Blade Only	Each	24
FPDC-2500LPB	1/4" and 1/2" Push Block	Each	12/48
FPDC-375LPB	3/8" Push Block	Each	12/48
FPDC-BMP	Replacement Bumper, 2-PC/Pack	Pack	24/144
FPDC-FET	Replacement Feet, 4-PC/Pack	Pack	12/72
FPDC-SCR	Replacement Thumb Screw	Each	100
FPDC-BSH	Replacement Bushing, 4-PC/Pack	Pack	24



FPDC-500L



FPDC-500LBDS



FPDC-375LBDS



FPDC-250LBDS



FPDC-375L



FPDC-250L



Fruit/Vegetable Wedge Cutter

- Cast aluminum construction with stainless steel blade and slip-resistant feet
- Ideal for cutting fruit or vegetable into equal-sized wedges

Item	Description	UOM	Case
FPWD-6	6-Section Cutter	Set	1
FPWD-8	8-Section Cutter	Set	1
FPWD-10	10-Section Cutter	Set	1
FPWD-6BDS	6-Section Blade Assembly	Each	24
FPWD-8BDS	8-Section Blade Assembly	Each	24
FPWD-10BDS	10-Section Blade Assembly	Each	24
FPWD-6PB	6-Section Push Block	Each	24
FPWD-8PB	8-Section Push Block	Each	24
FPWD-10PB	10-Section Push Block	Each	24
FPWD-KOB	Replacement Knob	Each	48
FPDC-FET	Replacement Feet, 4-PC/Pack	Pack	12/72
FPDC-BSH	Replacement Bushing, 4-PC/Pack	Pack	24



Tomato Slicer

- Durable, precision stainless steel blade in a strong cast aluminum body slices tomatoes into uniform pieces.
- Serrated blade cuts differently-textured tomatoes with ease.
- Pistol-grip handle allows for a secure grip and convenient operation.

Item	Description	UOM	Case
FPSL-38	3/8", Slicer	Set	1
FPSL-14	1/4", Slicer	Set	1
FPSL-316	3/16", Slicer	Set	1
FPSL-38BDS	3/8" Blade Assembly	Each	24
FPSL-14BDS	1/4" Blade Assembly	Each	24
FPSL-316BDS	3/16" Blade Assembly	Each	24
FPSL-38PB	3/8" Push Block	Each	10
FPSL-14PB	1/4" Push Block	Each	10
FPSL-316PB	3/16" Push Block	Each	10
FPDC-FET	Replacement Feet, 4-PC/Pack	Pack	12/72
FPDC-SCR	Replacement Thumb Screw	Each	100

French Fry Cutter

- Durable cast iron construction with razor-sharp stainless steel blade
- Ergonomic long handle for effortless operation
- Easy to clean and maintain

Item	Description	UOM	Case
FPFC-250	1/4", Cutter	Set	1
FPFC-375	3/8", Cutter	Set	1
FPFC-500	1/2", Cutter	Set	1
FPFC-250BD	1/4" Blade	Each	24
FPFC-375BD	3/8" Blade	Each	24
FPFC-500BD	1/2" Blade	Each	24
FPFC-250PB	1/4" Push Block	Each	24
FPFC-375PB	3/8" Push Block	Each	24
FPFC-500PB	1/2" Push Block	Each	24
FPFC-SP	Push Block Supporter	Each	12



FPFC-500



FPFC-250BD



FPFC-375BD



FPFC-500BD



FPFC-250



FPFC-375

Wall-Mountable French Fry Cutter

- Cast aluminum body and stainless steel blade
- Throw handle adds leverage and control for easy cutting.
- Wall bracket to mount the cutter to the wall for enhanced efficiency

Item	Description	UOM	Case
FPFC-500W	1/2", Cutter	Set	1
FPFC-375W	3/8", Cutter	Set	1
FPFC-250W	1/4", Cutter	Set	1
FPDC-500SBDS	1/2" Blade Assembly	Set	24
FPDC-375SBDS	3/8" Blade Assembly	Set	24
FPDC-250SBDS	1/4" Blade Assembly	Set	24
FPDC-500SBD	1/2" Blade Only	Each	12/24
FPDC-375SBD	3/8" Blade Only	Each	12/24
FPDC-250SBD	1/4" Blade Only	Each	12/24
FPDC-2500SPB	1/4" and 1/2" Push Block	Each	12/48
FPDC-375SPB	3/8" Push Block	Each	12/48
FPFC-WBR	Wall Bracket	Each	1/20
FPFC-WNT	Replacement Wing Nut	Each	100
FPDC-SCR	Replacement Thumb Screw	Each	100



FPFC-500W



FPFC-WNT



FPFC-WBR



FPFC-250W



FPFC-375W

Poly Food Storage Container

C.A.C. Poly Food Container Series provides food storage solutions in multiple materials, two shapes (square and round) and various sizes to meet ever-changing needs in any kitchens. Designed with convenient handles and easy-to-read gradations, this NSF-listed series is a great choice for restaurants, catering services and hospitality facilities.

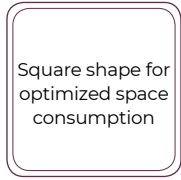

Clear

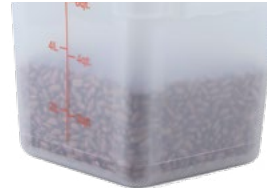

Translucent



White

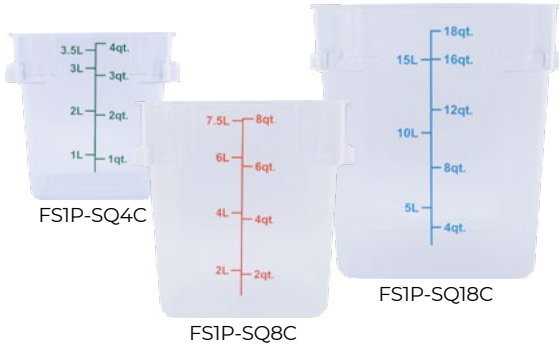

Square Clear Polycarbonate Container

- Clear body for enhanced visibility
- Temperature resistant from -40°F/-40°C to 210°F/99°C
- NSF listed; dishwasher safe; freezer safe; stackable



Item	Description	UOM	Case
FSIP-SQ2C	2QT	Each	6/24
FSIP-SQ4C	4QT	Each	12/48
FSIP-SQ6C	6QT	Each	12/24
FSIP-SQ8C	8QT	Each	12/24
FSIP-SQ12C	12QT	Each	12
FSIP-SQ18C	18QT	Each	12
FSIP-SQ22C	22QT	Each	6



Square Translucent Polypropylene Container

- Temperature resistant from -40°F/-40°C to 160°F/71°C
- NSF listed; BPA free; dishwasher safe; freezer safe; stackable



Item	Description	UOM	Case
FS2P-SQ2T	2QT	Each	6/24
FS2P-SQ4T	4QT	Each	12/48
FS2P-SQ6T	6QT	Each	12/24
FS2P-SQ8T	8QT	Each	12/24
FS2P-SQ12T	12QT	Each	12
FS2P-SQ18T	18QT	Each	12
FS2P-SQ22T	22QT	Each	6

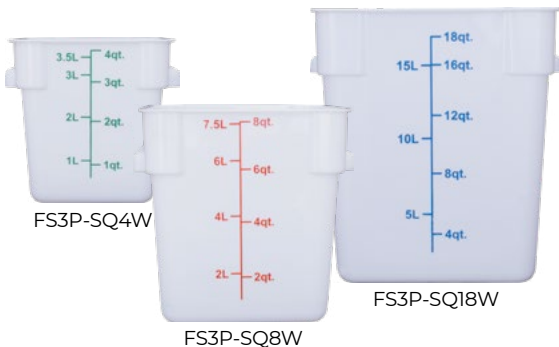

Square White Polypropylene Container

- Temperature resistant from -40°F/-40°C to 160°F/71°C
- NSF listed; BPA free; dishwasher safe; freezer safe; stackable



Item	Description	UOM	Case
FS3P-SQ2W	2QT	Each	6/24
FS3P-SQ4W	4QT	Each	12/48
FS3P-SQ6W	6QT	Each	12/24
FS3P-SQ8W	8QT	Each	12/24
FS3P-SQ12W	12QT	Each	12
FS3P-SQ18W	18QT	Each	12
FS3P-SQ22W	22QT	Each	6



Square Cover

- NSF listed; BPA free



Item	Description	UOM	Case
FSSQ-24CV-G	For 2QT, 4QT	Each	12
FSSQ-68CV-R	For 6QT, 8QT	Each	12
FSSQ-1282CV-BL	For 12QT, 18QT, 22QT	Each	6

Round Clear Polycarbonate Container

- Clear body for enhanced visibility
- Temperature resistant from -40°F/-40°C to 210°F/99°C
- NSF listed; dishwasher safe; freezer safe; stackable



Item	Description	UOM	Case
FS1P-1C	1QT	Each	48
FS1P-2C	2QT	Each	24
FS1P-4C	4QT	Each	12
FS1P-6C	6QT	Each	12
FS1P-8C	8QT	Each	12
FS1P-12C	12QT	Each	12
FS1P-18C	18QT	Each	6
FS1P-22C	22QT	Each	6
FS1R-1CV-C	Cover for 1QT	Each	12
FS1R-24CV-C	Cover for 2QT, 4QT	Each	12
FS1R-68CV-C	Cover for 6QT, 8QT	Each	12
FS1R-1282CV-C	Cover for 12QT, 18QT, 22QT	Each	6



Round Translucent Polypropylene Container

- Temperature resistant from -40°F/-40°C to 160°F/71°C
- NSF listed; BPA free; dishwasher safe; freezer safe; stackable



Item	Description	UOM	Case
FS2P-1T	1QT	Each	48
FS2P-2T	2QT	Each	24
FS2P-4T	4QT	Each	12
FS2P-6T	6QT	Each	12
FS2P-8T	8QT	Each	12
FS2P-12T	12QT	Each	12
FS2P-18T	18QT	Each	6
FS2P-22T	22QT	Each	6
FS2R-1CV-T	Cover for 1QT	Each	12
FS2R-24CV-T	Cover for 2QT, 4QT	Each	12
FS2R-68CV-T	Cover for 6QT, 8QT	Each	12
FS2R-1282CV-T	Cover for 12QT, 18QT, 22QT	Each	6



Round White Polypropylene Container

- Temperature resistant from -40°F/-40°C to 160°F/71°C
- NSF listed; BPA free; dishwasher safe; freezer safe; stackable



Item	Description	UOM	Case
FS3P-1W	1QT	Each	48
FS3P-2W	2QT	Each	24
FS3P-4W	4QT	Each	12
FS3P-6W	6QT	Each	12
FS3P-8W	8QT	Each	12
FS3P-12W	12QT	Each	12
FS3P-18W	18QT	Each	6
FS3P-22W	22QT	Each	6
FS3R-1CV-W	Cover for 1QT	Each	12
FS3R-24CV-W	Cover for 2QT, 4QT	Each	12
FS3R-68CV-W	Cover for 6QT, 8QT	Each	12
FS3R-1282CV-W	Cover for 12QT, 18QT, 22QT	Each	6





Clear Storage Box

- Made of durable polycarbonate for enhanced temperature resistance, withstanding from -40°F/-40°C to 212°F/100°C
- Clear body for exceptional visibility
- NSF listed; dishwasher safe; freezer safe; stackable



FSIF-15C



FSIF-12C



FSIF-9C



FSIF-6C



FSIF-3C

Item	Description	Size	UOM	Case
FSIF-3C	Full Size	26" x 18" x 3"	Each	6
FSIF-6C	Full Size	26" x 18" x 6"	Each	6
FSIF-9C	Full Size	26" x 18" x 9"	Each	4
FSIF-12C	Full Size	26" x 18" x 12"	Each	3
FSIF-15C	Full Size	26" x 18" x 15"	Each	3
FSIF-CV-C	Cover, Full Size	26" x 18"	Each	12
FSIH-3C	Half Size	18" x 12" x 3-1/2"	Each	12
FSIH-6C	Half Size	18" x 12" x 6"	Each	6
FSIH-9C	Half Size	18" x 12" x 9"	Each	6
FSIH-CV-C	Cover, Half Size	18" x 12"	Each	24



White Storage Box

- Durable polyethylene construction for stain- and odor-resistance
- Temperature resistant from -40°F/-40°C to 160°F/71°C
- NSF listed; BPA free; dishwasher safe; freezer safe; stackable



Item	Description	Size	UOM	Case
FS4F-3W	Full Size	26" x 18" x 3"	Each	6
FS4F-6W	Full Size	26" x 18" x 6"	Each	6
FS4F-9W	Full Size	26" x 18" x 9"	Each	6
FS4F-12W	Full Size	26" x 18" x 12"	Each	6
FS4F-15W	Full Size	26" x 18" x 15"	Each	6
FS4F-CV-W	Cover, Full Size	26" x 18"	Each	6
FS4H-3W	Half Size	18" x 12" x 3"	Each	12
FS4H-6W	Half Size	18" x 12" x 6"	Each	12
FS4H-9W	Half Size	18" x 12" x 9"	Each	12
FS4H-CV-W	Cover, Half Size	18" x 12"	Each	6





BTBX-W & BTBX-CV-W

Polypropylene Storage Box

- Durable and compact storage box with great versatility
- Ideal to hold various items from food to flatware
- Compatible lid available and sold separately
- BPA free



Item	Description	Color	UOM	Case
BTBX-W	14-1/2" x 12-1/2" x 5-1/2"H	White	Each	24
BTBX-CV-W	Lid for BTBX-W	White	Each	24



IBSC-32SD

Polypropylene Storage Container

- Made of durable polypropylene for enhanced crack-, chip- and dent-resistance and long-lasting performance
- Ergonomic side handles for improved comfortability and efficiency during transporting
- White sliding lid with a clear half side allows for one-hand operation and see-through visibility.
- Lid (sold separately) seals the container for proper storage and transporting.
- Stackable for easy storage
- NSF listed; BPA free: storage containers and non-sliding lids
- IBSC-32: ship by freight only; UPS small package not available



Item	Description	Color	UOM	Case
IBSC-10	10 Gallon	White	Each	6
IBSC-20	20 Gallon	White	Each	6
IBSC-32	32 Gallon	White	Each	6
IBSC-10SD	Sliding Lid for IBSC-10	White/Clear	Each	6
IBSC-20SD	Sliding Lid for IBSC-20	White/Clear	Each	6
IBSC-32SD	Sliding Lid for IBSC-32	White/Clear	Each	6
IBSC-10LD	Lid for IBSC-10	White	Each	24
IBSC-20LD	Lid for IBSC-20	White	Each	12
IBSC-32LD	Lid for IBSC-32	White	Each	12



IBSC-32LD



IBSC-32



Ingredient Bin

- Made of heavy-duty, rust- and corrosion-resistant polypropylene, perfect for high volume use
- Secure lid with clear window for proper dry ingredient storage and see-through visibility
- One-hand operation with a included scoop for enhanced efficiency
- NSF listed

Mobile Ingredient Bin

- Large storage capacity available in 21 gallon and 27 gallon
- Perfect size with excellent versatility easily fits most under-the-table spacing and meets various storage needs.
- Four 3" non-marking casters, two with brake, for easy transporting
- NSF listed



IBIN-27

Item	Description	UOM	Case
IBIN-21	21 Gallon	Set	1
IBIN-27	27 Gallon	Set	1
IBIN-21LD	Lid for IBIN-21	Each	6
IBIN-27LD	Lid for IBIN-27	Each	6
IBIN-217C	Caster for IBIN-21/27	Each	20
IBIN-217CB	Brake Caster for IBIN-21/27	Each	20



Scoop and Scoop Holder



Caster with Brake

	Item	Sugar Weight	Flour Weight
Shelf Ingredient Bin	IBIN-3	18 lbs	12 lbs
	IBIN-6	44 lbs	30 lbs
	IBIN-13	89 lbs	60 lbs
Mobile Ingredient Bin	IBIN-21	160 lbs	125 lbs
	IBIN-27	200 lbs	155 lbs

Shelf Ingredient Bin

- First-in-first-out dispensing with a cleverly-constructed vertical barrier to keep ingredient fresh and meet sanitation requirements
- Stackable and compact in size with excellent versatility easily fits any shelving system and meets various storage needs.
- NSF listed



Item	Description	UOM	Case
IBIN-3	40 Cup/2.6 Gallon	Set	1
IBIN-6	100 Cup/6.3 Gallon	Set	1
IBIN-13	200 Cup/12.6 Gallon	Set	1
IBIN-3SCP	Scoop for IBIN-3, 0.5 Cup	Each	50
IBIN-613SCP	Scoop for IBIN-6/13, 2.5 Cup	Each	50
IBIN-3LD	Lid for IBIN-3	Each	8
IBIN-6LD	Lid for IBIN-6	Each	4
IBIN-13LD	Lid for IBIN-13	Each	4

* NSF listing numbers: SBIN-42, SBIN-101, SBIN-202



First-in-first-out Dispensing



Stackable Design



IBIN-3



IBIN-6



IBIN-13



ACWS Set

Chrome Plated Wire Shelving Set

- Perfect storage or display solution for both storefront and back of the house
- Heavy-duty, chrome-coated metal construction for exceptional protection against rusting and corrosion
- Each individual shelf accommodates up to 850 lbs.
- Temperature range: -100°F/-73°C to 500°F/260°C
- One set includes 4 shelves, 4 posts (72"H), and 16 clips.
- Ships flat; minimal assembly required; no tools needed
- NSF listed



Item	Description	UOM	Case
ACWS-1836S	36"L x 18"W x 72"H	Set	1
ACWS-2436S	36"L x 24"W x 72"H	Set	1
ACWS-1848S	48"L x 18"W x 72"H	Set	1
ACWS-2448S	48"L x 24"W x 72"H	Set	1



ACWS Shelf

Chrome Plated Wire Shelf

- 4 clips are included for every shelf.
- Weight capacity: length below 48" accommodate up to 850 lbs; length equal to or above 48" accommodates up to 600 lbs
- NSF listed
- Sold by case



Item	Description	UOM	Case
ACWS-1424	24" x 14"	Each	2
ACWS-1430	30" x 14"	Each	2
ACWS-1436	36" x 14"	Each	2
ACWS-1448	48" x 14"	Each	2
ACWS-1460	60" x 14"	Each	2
ACWS-1472	72" x 14"	Each	2
ACWS-1824	24" x 18"	Each	2
ACWS-1830	30" x 18"	Each	2
ACWS-1836	36" x 18"	Each	2
ACWS-1842	42" x 18"	Each	2
ACWS-1848	48" x 18"	Each	2
ACWS-1854	54" x 18"	Each	2
ACWS-1860	60" x 18"	Each	2
ACWS-1872	72" x 18"	Each	2
ACWS-2124	24" x 21"	Each	2
ACWS-2130	30" x 21"	Each	2
ACWS-2136	36" x 21"	Each	2
ACWS-2148	48" x 21"	Each	2
ACWS-2160	60" x 21"	Each	2
ACWS-2172	72" x 21"	Each	2
ACWS-2424	24" x 24"	Each	2
ACWS-2430	30" x 24"	Each	2
ACWS-2436	36" x 24"	Each	2
ACWS-2442	42" x 24"	Each	2
ACWS-2448	48" x 24"	Each	2
ACWS-2454	54" x 24"	Each	2
ACWS-2460	60" x 24"	Each	2
ACWS-2472	72" x 24"	Each	2

Epoxy Coated Wire Shelving Set

- Perfect storage or display solution for both storefront and back of the house
- Heavy-duty, epoxy-coated metal construction ideal in all environments including refrigerators, freezers, warewashing areas with optimal protection against abrasion, humidity, turbulence, and temperature changes
- Each individual shelf accommodates up to 850 lbs.
- Temperature range: -100°F/-73°C to 500°F/260°C
- One set includes 4 shelves, 4 posts (72"H), and 16 clips.
- Ships flat; minimal assembly required; no tools needed
- NSF listed



Item	Description	UOM	Case
AEWS-1836S	36"L x 18"W x 72"H	Set	1
AEWS-2436S	36"L x 24"W x 72"H	Set	1
AEWS-1848S	48"L x 18"W x 72"H	Set	1
AEWS-2448S	48"L x 24"W x 72"H	Set	1



AEWS Set

Epoxy Coated Wire Shelf

- 4 clips are included for every shelf.
- Weight capacity: length below 48" accommodate up to 850 lbs; length equal to or above 48" accommodate up to 600 lbs
- NSF listed
- Sold by case



Item	Description	UOM	Case
AEWS-1424	24" x 14"	Each	2
AEWS-1430	30" x 14"	Each	2
AEWS-1436	36" x 14"	Each	2
AEWS-1448	48" x 14"	Each	2
AEWS-1460	60" x 14"	Each	2
AEWS-1472	72" x 14"	Each	2
AEWS-1824	24" x 18"	Each	2
AEWS-1830	30" x 18"	Each	2
AEWS-1836	36" x 18"	Each	2
AEWS-1842	42" x 18"	Each	2
AEWS-1848	48" x 18"	Each	2
AEWS-1854	54" x 18"	Each	2
AEWS-1860	60" x 18"	Each	2
AEWS-1872	72" x 18"	Each	2
AEWS-2124	24" x 21"	Each	2
AEWS-2130	30" x 21"	Each	2
AEWS-2136	36" x 21"	Each	2
AEWS-2148	48" x 21"	Each	2
AEWS-2160	60" x 21"	Each	2
AEWS-2172	72" x 21"	Each	2
AEWS-2424	24" x 24"	Each	2
AEWS-2430	30" x 24"	Each	2
AEWS-2436	36" x 24"	Each	2
AEWS-2442	42" x 24"	Each	2
AEWS-2448	48" x 24"	Each	2
AEWS-2454	54" x 24"	Each	2
AEWS-2460	60" x 24"	Each	2
AEWS-2472	72" x 24"	Each	2

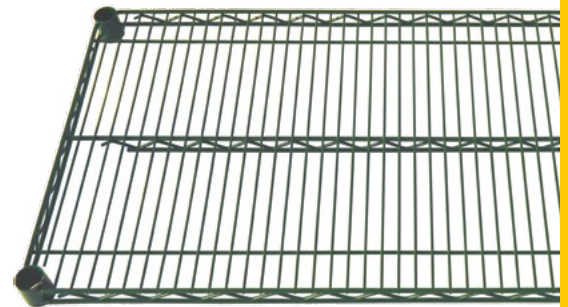

AEWS Shelf



Epoxy Coated Post

- NSF listed: 8"H, 34"H, 63"H & 72"H
 - Sold by case



Item	Description	UOM	Case
AECP-08	8"H	Each	4
AECP-33	34"H	Each	4
AECP-63	63"H	Each	4
AECP-72	72"H	Each	4
AECP-86	86"H	Each	4



Chrome Plated Post

- NSF listed: 8"H, 34"H, 63"H & 72"H
 - Sold by case



Item	Description	UOM	Case
ACCP-08	8"H	Each	4
ACCP-33	34"H	Each	4
ACCP-63	63"H	Each	4
ACCP-72	72"H	Each	4
ACCP-86	86"H	Each	4



Epoxy Coated Wall Bracket

- Use 2 wall brackets and 1 wire shelf to create a shelving unit on the wall.
 - Sold by case

Item	Description	UOM	Case
AEWS-14BR	For AEWS-14 Series	Each	2
AEWS-18BR	For AEWS-18 Series	Each	2
AEWS-21BR	For AEWS-21 Series	Each	2
AEWS-24BR	For AEWS-24 Series	Each	2

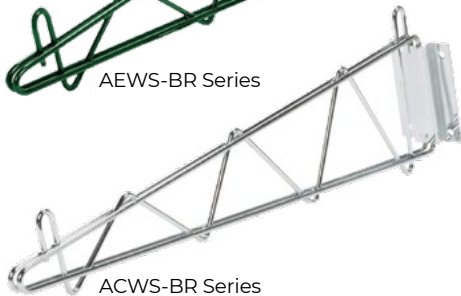

Chrome Plated Wall Bracket

- Use 2 wall brackets and 1 wire shelf to create a shelving unit on the wall.
 - Sold by case

Item	Description	UOM	Case
ACWS-14BR	For ACWS-14 Series	Each	2
ACWS-18BR	For ACWS-18 Series	Each	2
ACWS-21BR	For ACWS-21 Series	Each	2
ACWS-24BR	For ACWS-24 Series	Each	2



Wire Shelving Accessory

- "S" hook can securely fasten multiple shelving units next to each other.
 - Leveling feet help shelving units stand steady on uneven ground.

Item	Description	UOM	Case
ACWS-HK	Silver "S" Hook for ACWS Series	Each	20/200
AEWS-HK	Green "S" Hook for AEWS Series	Each	20/200
ACWS-LF	Leveling Foot for ACWS & AEWS Series, 4-PC/Pack	Pack	100

Chrome Plated Wire Cart



- Convenient, compact transporting and display solution
- Chrome-plated metal construction for exceptional protection against rusting and corrosion
- Each individual shelving tier accommodates up to 850 lbs.
- Temperature range: -100°F/-73°C to 500°F/260°C
- One set includes 3 shelves, 2 handles, 4 posts, 4 casters (2 with brake) and 16 clips (2 for each handle).
- Ships flat; minimal assembly required; no tools needed
- NSF-listed shelving tiers

Item	Description	UOM	Case
ACCW-1836S	3-Tier, 36" x 18" x 42"H	Set	1
ACCW-2448S	3-Tier, 48" x 24" x 42"H	Set	1



ACCW-1836S

Wire Cart/Shelving Accessory

- Extended handles are made of durable and chrome-plated metal.
- 2 sleeve clips come with each handle.
- For ACWS, AEWS and ACCW series

Item	Description	UOM	Case
ACWS-14H	Extended Handle, 14"	Each	12
ACWS-18H	Extended Handle, 18"	Each	12
ACWS-21H	Extended Handle, 21"	Each	12
ACWS-24H	Extended Handle, 24"	Each	12
ACWS-C	Caster, 5"	Each	4/24
ACWS-CB	Brake Caster, 5"	Each	4/24
ACWS-CLP	Sleeve Clip, 4-PC/Pack	Pack	150

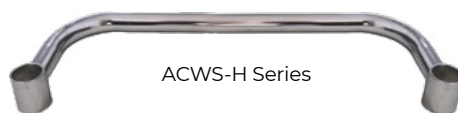

ACWS-H Series



ACWS-C



ACWS-CB



ACWS-CLP

Dunnage Rack



- Sturdy and heavy-duty welded aluminum construction withstands up to 1800 lbs.
- Compact off-the-floor storage solution for enhanced sanitation
- Ships fully assembled
- NSF listed

Item	Description	UOM	Case
ALDR-1424E	24" x 14" x 8"H	Each	8
ALDR-2036E	36" x 20" x 8"H	Each	6
ALDR-2036	36" x 20" x 12"H	Each	6
ALDR-2048E	48" x 20" x 8"H	Each	6
ALDR-2048	48" x 20" x 12"H	Each	6
ALDR-2060E	60" x 20" x 8"H	Each	6
ALDR-2060	60" x 20" x 12"H	Each	6



ALDR Series

Anti-Fatigue Rubber Floor Mat

- Constructed from premium quality rubber
- Helps to ensure safe and productive work environment by offering stable and comfortable footing
- Anti-fatigue and slip-resistant; durable and grease-resistant
- Exceptional drainage helps to ensure workplace safety.

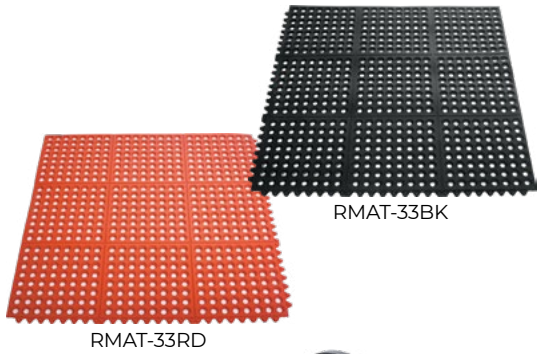

Interlocking Floor Mat

-Configurable based on changing needs

Item	Description	Color	UOM	Case
RMAT-33BK	3' x 3' x 1/2"	Black	Each	1
RMAT-33RD	3' x 3' x 1/2"	Red	Each	1



Beveled Edge Floor Mat

-Beveled edge design helps to reduce trip hazards.

Item	Description	Color	UOM	Case
RMAT-35BK-B	5' x 3' x 1/2"	Black	Each	1
RMAT-35RD-B	5' x 3' x 1/2"	Red	Each	1

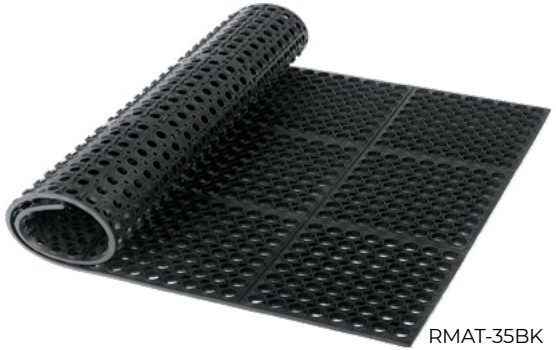

Straight Edge Floor Mat

-Heavy-duty 3/4" in thickness

Item	Description	Color	UOM	Case
RMAT-35BK	5' x 3' x 3/4"	Black	Each	1
RMAT-35RD	5' x 3' x 3/4"	Red	Each	1

Vinyl-Backed Floor Mat

- Designed with vinyl backing and tapered edge, helping to prevent curling and ripping
- Durable and bend-resistant construction for safe footing



Carpet Floor Mat

Item	Description	Color	UOM	Case
PMAT-53CH	5' x 3'	Charcoal	Each	1
PMAT-53BY	5' x 3'	Burgundy	Each	1
PMAT-64CH	6' x 4'	Charcoal	Each	1
PMAT-64BY	6' x 4'	Burgundy	Each	1
PMAT-103CH	10' x 3'	Charcoal	Each	1
PMAT-103BY	10' x 3'	Burgundy	Each	1

Mop Bucket

- Heavy-duty construction with capacity of 36QT
- Removable side-press wringer makes it easy to transport cleaning supplies and wring out mops.
- Large bucket allows for conveniently mixing cleaning solutions and easily rinsing mops.
- 3" non-marking casters for enhanced mobility; included bumpers protect bucket from knocking against wall or other objects

Item	Description	UOM	Case
PMBY-36ST	36QT Set, Yellow	Set	1
PMBY-36WG	Side-Press Wringer for PMBY-36ST	Each	2
PMBY-36BT	Bucket for PMBY-36ST	Each	1
PMBY-36CB	Caster with Bumper for PMBY-36ST, 4 Sets/Pack	Pack	20



Wet Floor Sign

- Easy to set up and fold flat for convenient service and storage
- Clear caution warning in both English and Spanish with red graphic highlights

Item	Description	UOM	Case
SCWF-A	A Shape	Each	12



Mop Handle

- Long handle ideal for cleaning hard-to-reach corners and in most settings
- Hanging hole for convenient storage

Poly Mop Handle

- Thumbwheel head holds mop firmly in place.
- Side gate for quick and hassle-free mop change

Item	Description	UOM	Case
MHLP-TW57	Poly Thumbwheel Frame w/ Side-Gate, 57"	Each	6

Metal Mop Handle

- Stirrup, durable metal head secures mop for sturdy handling.
- Heavy duty for long-lasting use

Item	Description	UOM	Case
MHLM-ST57	Metal Stirrup Frame, 57"	Each	6

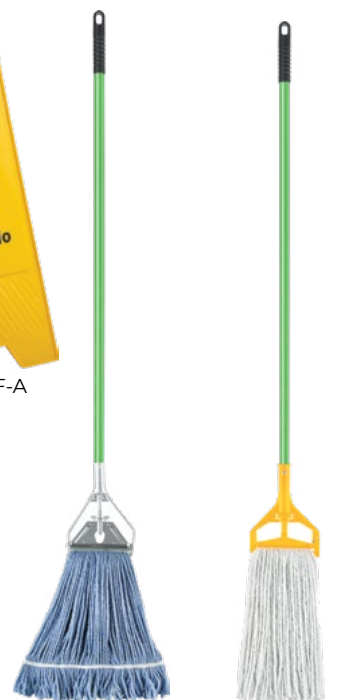

Mop Head

- Universal 1-1/4" headband
- Absorbent cotton-poly blend in reliable 4-ply yarn
- Machine washable

Looped-End Mop Head

- Tailband with loops allows for wider surface coverage and less tangling and fraying.
- Added strength stands up to intensive use.

Item	Description	Color	UOM	Case
MHD2-24BL	24oz	Blue	Each	20
MHD2-32BL	32oz	Blue	Each	20
MHD2-24WT	24oz	White	Each	20
MHD2-32WT	32oz	White	Each	20



MHLM-ST57
Assembled with
MHD2-24BL

MHLP-TW57
Assembled with
MHD1-24WT

Cut-End Mop Head

- Classic cut-end design for general purpose mopping

Item	Description	Color	UOM	Case
MHD1-24BL	24oz	Blue	Each	20
MHD1-32BL	32oz	Blue	Each	20
MHD1-24WT	24oz	White	Each	20
MHD1-32WT	32oz	White	Each	20



Universal 1-1/4" Headband



SQGE-12R



BRM1-55F



DPUP-13C



PLGW-24

Lobby Broom

- Hardwearing, flagged bristles sweep up fine dirt and debris.
- Angled design helps reach underneath furniture, along walls, and into out-of-the-way areas.

Item	Description	UOM	Case
BRM1-55F	Flagged Angled 55"	Each	12

Lobby Dust Pan

- Windbreak cover enables "clean as you go" and mess-free transport.
- Long, easy-grip handle for easy sweeping in an upright position
- 13" wide hopper tackles extra waste for efficient cleaning.

Item	Description	UOM	Case
DPUP-13C	Upright w/ Cover and Handle 13"W	Each	10

Squeegee

- All-in-one design of single rubber blade with drying sponge on the other side
- 23" handle for reaching farther range
- Useful tool for cleaning semi-smooth surface to leave a spotless and streak-free shine

Item	Description	UOM	Case
SQGE-12R	Red w/ Handle 12"W	Each	6/24

Rubber Plunger

- Sturdy and heavy duty, ideal for removing drain clogs

Item	Description	UOM	Case
PLGW-24	Wooden Handle 24"	Each	24



CLMF-16MC



Microfiber Cloth

- Super absorbent microfiber enhances cleaning power.
- Efficiently traps dirt, liquid, grime and more
- Cost-effective solution by requiring less water and chemical usage than standard cotton cloth
- Soft and non-abrasive texture for a scratch-, streak- and lint-free result
- Ideal for cleaning and dusting a variety of surfaces

Item	Description	UOM	Case
CLMF-16WT	White, 6-PC/Pack	Pack	20
CLMF-16MC	Multi-Color, 6-PC/Pack	Pack	20



SPDF-9G



SPDS-105

Scouring Pad

- Strong and flexible pad made of quality synthetic fiber
- Superior commercial grade
- Stretch-, shrink-, and abrasion-resistant
- Removes tough messes
- Multipurpose, easy to care and fast-drying

Item	Description	UOM	Case
SPDF-9G	6" x 9", 6-PC/Pack	Pack	60

Stainless Steel Scouring Pad

- Stainless steel coils for heavy-duty use
- Tackles tough grease stains, burnt food residue and more

Item	Description	UOM	Case
SPDS-50	50g, Standard	Each	12/144
SPDS-105	105g, Heavyweight	Each	12/72



SPBT-28G



SPBT-28R

Spray Bottle

- High density polyethylene bottle with color-coded trigger
- Label-free body with molded-in graduations in both oz and ML

Item	Description	UOM	Case
SPBT-28R	28oz/900ML, Red	Each	50
SPBT-28G	28oz/900ML, Green	Each	50

Disposable Vinyl Glove 📦

- Strong tensile strength with excellent touch sensitivity
- Easy on/off and ultra soft texture help to reduce hand fatigue.
- Powder free
- Latex free

Item	Description	UOM	Case
GLVL-M	Medium, 100-PC/Pack	Pack	1/10
GLVL-L	Large, 100-PC/Pack	Pack	1/10



GLVL Series

Disposable PE Glove 📦

- Embossed texture for secure grip
- Ambidextrous fit with strong seam
- Latex free

Item	Description	UOM	Case
GLPE-M	Medium, 500-PC/Pack	Pack	1/10
GLPE-L	Large, 500-PC/Pack	Pack	1/10



GLPE Series

Utility Bucket

- Heavy-duty, high-density poly construction for added strength and long-lasting performance
- Stainless steel handle for easy lifting and transporting
- Built-in pour spout and molded-in graduations in gallon, quart, and pint
- Versatile and ideal for various tasks

Item	Description	Color	UOM	Case																								
BTRS-10GY	10QT	Gray	Each	12																								
BTRS-10GN	10QT	Green	Each	12																								
BTRS-10RD	10QT	Red	Each </tr <tr> <td>BTRS-10WT</td> <td>10QT</td> <td>White</td> <td>Each</td> <td>12</td> </tr> <tr> <td>BTRS-14GY</td> <td>14QT</td> <td>Gray</td> <td>Each</td> <td>12</td> </tr> <tr> <td>BTRS-14GN</td> <td>14QT</td> <td>Green</td> <td>Each</td> <td>12</td> </tr> <tr> <td>BTRS-14RD</td> <td>14QT</td> <td>Red</td> <td>Each</td> <td>12</td> </tr> <tr> <td>BTRS-14WT</td> <td>14QT</td> <td>White</td> <td>Each</td> <td>12</td> </tr>	BTRS-10WT	10QT	White	Each	12	BTRS-14GY	14QT	Gray	Each	12	BTRS-14GN	14QT	Green	Each	12	BTRS-14RD	14QT	Red	Each	12	BTRS-14WT	14QT	White	Each	12
BTRS-10WT	10QT	White	Each	12																								
BTRS-14GY	14QT	Gray	Each	12																								
BTRS-14GN	14QT	Green	Each	12																								
BTRS-14RD	14QT	Red	Each	12																								
BTRS-14WT	14QT	White	Each	12																								



BTRS-14GY



BTRS-10GY



BTRS-10GN



BTRS-10RD



BTRS-10WT

Cleaning Bucket

- Compliant with HACCP color coding guidelines with inner graduations
- Multilingual instructions in English, Spanish, and French
- Green bucket for cleaning solution
- Red bucket for sanitizing solution
- Yellow bucket for general cleaning use with space for labeling

Item	Description	Capacity	Color	UOM	Case
BTCL-3G	Cleaning	3QT	Green	Each	12
BTCL-6G	Cleaning	6QT	Green	Each	12
BTSZ-3R	Sanitizing	3QT	Red	Each	12
BTSZ-6R	Sanitizing	6QT	Red	Each	12
BTGP-3Y	General Purpose	3QT	Yellow	Each	12
BTGP-6Y	General Purpose	6QT	Yellow	Each	12



BTGP-3Y

BTCL-3G

BTSZ-6R



APVL-1PK

Dishwashing Apron 🛒

- Heavy-duty; water-, stain- and cut-resistant
- Perfect for dishwashing and cleaning

Item	Description	Color	UOM	Case
APVL-1PK	Vinyl, 41-1/4" x 21-1/2"	Black	Each	12/24
APLX-45K	Latex, 44-1/2" x 37"	Black	Each	12
APNL-2K	Nylon Blend, 40" x 25-1/2"	Black	Each	12/60
APVL-3BN	Heavyweight Vinyl, 40" x 27-1/2"	Brown	Each	12/60



APVL-3BN



APLX-45K, Adjustable Neck Strap & Waist Ties



APLX-45K, Apron Body

Heavy-Duty Latex Glove 🛒

- Long cuff covers lower arm for better protection.
- Water-, stain- and cut-resistant
- Multipurpose; powder-free

Item	Description	UOM	Case
GLLX-1HD	18-1/2"L, Black	Pair	12/24



GLLX-1HD

Reusable Latex Glove 🛒

- Designed with embossed texture for secure grip
- Water- and stain-resistant
- Great protective barrier for performing tasks
- Powder-free

Item	Description	UOM	Case
GLLX-2YS	Yellow, S	Pair	12/60
GLLX-2YM	Yellow, M	Pair	12/60
GLLX-2KL	Black, L	Pair	12/60



GLLX-2YM



GLLX-2KL



Embossed Texture for Secure Grip

Range Hood Filter

- Durable stainless steel construction delivers long-lasting performance.
- Baffles help to trap solids and grease for improved workplace safety.
- Easy to clean with soap and water, or degreaser
- Dishwasher safe

Item	Size	UOM	Case
SRHF-1616	16"W x 16"H	Each	1/6
SRHF-1620	16"W x 20"H	Each	1/6
SRHF-1625	16"W x 25"H	Each	1/6
SRHF-2016	20"W x 16"H	Each	1/6
SRHF-2020	20"W x 20"H	Each	1/6
SRHF-2025	20"W x 25"H	Each	1/6
SRHF-2520	25"W x 20"H	Each	1/6



SRHF-2520

Durable Stainless Steel Construction Delivers Long-Lasting Performance!



SRHF-1616

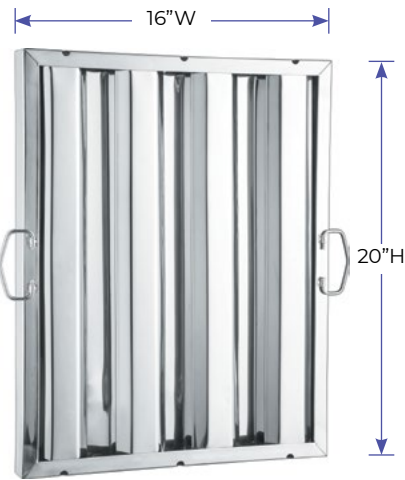

SRHF-1620



SRHF-1625



SRHF-2016



SRHF-2020



SRHF-2025

Cleaning Brush

C.A.C. Cleaning Brush Series offers a wide selection of brushes to meet various cleaning needs in busy kitchens of restaurants, bistros, pizzerias, bars, schools, healthcare facilities and more. As choosing the right tool for the right task will make your cleaning process easier, C.A.C. cleaning brushes are available in different types, shapes, lengths and materials to provide ideal solutions to both general cleanings and vigorous cleanings.



B2OS-27

Pizza Oven Brush with Scraper

- Durable carbon steel wire bristle for efficient cleaning and long-lasting performance
- Metal steel scraper ideal for removing rust, tough debris, grease, carbonized burnt food and more
- 27" smooth wooden handle offers a reliable grip while ensuring a safe distance from heat during cleaning.
- Metal ferrule securely connects the brush head with handle for reinforced strength and durability.

Item	Description	UOM	Case
B2OS-27	Carbon Steel Wire Bristle w/ Scraper, 27" Wooden Handle	Each	12



Metal Steel Scraper



Metal Ferrule of B2PO-36/60

Pizza Oven Brush Head and Handle

- Brush head (sold separately) is designed with hardwood base, metal scraper and strong brass bristle for easy scrubbing and removal of caked-on carbon debris and heavy grease.
- Threaded wooden handle available in 36" and 60" (sold separately) is equipped with a metal ferrule to securely fit the brush head for enhanced durability and to help meet versatile cleaning needs.

Item	Description	UOM	Case
B2PO-10H	Brush Head w/ Scraper, 10"L	Each	12/48
B2PO-36	36" Wooden Handle	Each	48
B2PO-60	60" Wooden Handle	Each	6/24

B2PO-10H assembled with B2PO-36

Oven/Broiler/Grill Brush

- Double-sided stainless steel bristle with metal scraper perfect for removing rust, tough debris, grease, carbonized burnt food and more.
- 30" long handle makes it easy to clean hard-to-reach areas while keeping a safe distance from heat during cleaning.
- Painted finish with metal ferrule offers a smooth grip and enhanced performance.

Item	Description	UOM	Case
B2BG-30S	Stainless Steel Bristle w/ Scraper, 30" Handle	Each	8/32



B2BG-30S



Metal Scraper

Double-Head Broiler/Grill Brush

- Heavy-duty construction with bent stainless steel handle for enhanced durability and leverage
- Thick flat bristle ideal for scraping heavy grease and stubborn residue
- Flexible medium brushing bristle great for general cleaning tasks
- Ergonomically angled head and handle for easy and comfortable maneuver

Item	Description	UOM	Case
B2BG-28D	Steel Wire Bristle, 28" Stainless Steel Handle	Each	6



Heavy-Duty Double-Head Brush



B2BG-28D

Oven/Broiler/Grill Brush with Bent Handle

- Thick 1-1/4"L flat steel wire scraping bristle ideal for vigorous cleaning tasks
- Beechwood brush head with metal handle for added strength and durability
- 23" long and bent handle offers excellent leverage while ensuring a safe operating distance from heat.

Item	Description	UOM	Case
B3BG-23B	23" Bent Handle	Each	12



B3BG-23B

Butcher Block Brush

- Heavy-duty 1-1/4"L steel wire bristle perfect for scraping away top-layer contaminants on butcher blocks and cutting boards
- Durable wooden base with smooth wooden handle offers long-lasting performance and anti-slip grip.

Item	Description	UOM	Case
B3BU-9S	Steel Wire Bristle, 9-1/4"L	Each	6/12



B3BU-9S

Utility Brush with Scraper

- Narrow solid wood base, wire bristle and metal scraper allow for deep reaching and thorough cleaning of broiler, grill, oven and more.
- Strong scraper works great on tough baked-on grease and grime.
- 1-1/2"L wire bristle ideal for efficient scrubbing

Item	Description	UOM	Case
B3UT-21W	Wire Bristle w/ Scraper, 20-1/2"L	Each	6/48



B3UT-21W

Utility Brush

- Slim shape adds flexibility when cleaning tight and hard-to-reach places.
- Lightweight with finger curve contour on the handle makes one-hand operation easy like a breeze.
- Available in stainless steel bristle and brass bristle

Item	Description	UOM	Case
B3UT-7B	Brass Bristle, 7"L	Each	48/576
B3UT-7S	Steel Bristle, 7"L	Each	48/576



B3UT-7B

B3UT-7S



BTDB-7GY



BTDB-7WT



BTCV-57BK



BTCV-57GY



BTCB-4P



SSFC-P



SSFC-S

Bus Box

- Heavy-duty construction perfect for holding heavy soiled dishes
- Convenient handles for easy and reliable transporting
- Matching covers are sold separately.
- BPA free



Item	Size	Color	UOM	Case
BTDB-5BK	22"L x 15-3/4"W x 5"H	Black	Each	1
BTDB-5GY	22"L x 15-3/4"W x 5"H	Gray	Each	1
BTDB-5WT	22"L x 15-3/4"W x 5"H	White	Each	1
BTDB-7BK	22"L x 15-3/4"W x 7"H	Black	Each	1
BTDB-7GY	22"L x 15-3/4"W x 7"H	Gray	Each	1
BTDB-7WT	22"L x 15-3/4"W x 7"H	White	Each	1

Bus Box Cover

- For BTDB series
- BPA free



Item	Size	Color	UOM	Case
BTCV-57BK	23-1/4"L x 16-7/8"W	Black	Each	1
BTCV-57GY	23-1/4"L x 16-7/8"W	Gray	Each	1
BTCV-57WT	23-1/4"L x 16-7/8"W	White	Each	1

Flatware Organizer/Cutlery Bin

- Durable polypropylene body in compact size helps to keep utensils organized and clean.

Item	Description	UOM	Case
BTCB-4P	4-Compartment, Black	Each	12

Flatware Cylinder

- Stainless steel

Item	Description	UOM	Case
SSFC-P	Perforated	Each	12/48
SSFC-S	Solid	Each	12/48

Heavy-Duty White Trash Can

- Constructed with durable polypropylene for enhanced crack-, chip- and dent-resistance and long-lasting performance
- Ergonomic side handles help to reduce work fatigue for improved comfortability and efficiency.
- Sliding lid with clear half side allows for one-hand operation and see-through visibility.
- Lid (sold separately) seal properly with the can for convenient waste storage and transporting.
- Stackable for easy storage
- NSF listed; BPA free: trash cans and non-sliding lids
- IBSC-32: ship by freight only; UPS small package not available



Item	Description	UOM	Case
IBSC-10	10 Gallon	Each	6
IBSC-20	20 Gallon	Each	6
IBSC-32	32 Gallon	Each	6
IBSC-10LD	Lid for IBSC-10	Each	24
IBSC-20LD	Lid for IBSC-20	Each	12
IBSC-32LD	Lid for IBSC-32	Each	12
IBSC-10SD	Sliding Lid for IBSC-10	Each	6
IBSC-20SD	Sliding Lid for IBSC-20	Each	6
IBSC-32SD	Sliding Lid for IBSC-32	Each	6



IBSC-32SD



IBSC-32LD



IBSC-32



Commercial Gray Trash Can

- Made of durable polyethylene for enhanced crack-, chip- and dent-resistance and long-lasting performance
- Reinforced top rim and double bottom surrounding edge improve overall stability to withstand heavy use.
- Ergonomic side handles help to reduce work fatigue for improved comfortability and efficiency.
- Leak-resistant lid (sold separately) ensures proper waste storage and transporting.
- Stackable for easy storage
- TCNC-32 and TCNC-45: ship by freight only; UPS small package not available

Item	Description	UOM	Case
TCNC-32	32 Gallon	Each	1
TCNC-45	44 Gallon	Each	1
TCNC-32LD	Lid for TCNC-32	Each	6/12
TCNC-45LD	Lid for TCNC-45	Each	6/12



TCNC-32LD



TCNC-32



Reinforced Top Rim



Double Bottom Surrounding Edge



UCSS-30

Stainless Steel Cart

- Durable 3-tier stainless steel construction
- One set includes 4 non-marking casters (2 with brake) for easy transporting.
- Ships flat; minimal assembly required
- Additional casters are sold separately.

Item	Description	UOM	Case
UCSS-30	30" x 16" x 33"	Set	1
UCSS-30-C	Caster for UCSS-30	Each	48
UCSS-30-CB	Brake Caster for UCSS-30	Each	48



BTUC series shown with accessory bins (sold separately).

Utility Cart

- 3-tier heavy-duty shelves provide optimal durability and reliability.
- 4 smooth rolling casters (2 with brake) for easy transporting
- BTUC-17 series weighs 15.5 lbs, holds up to 330lbs; BTUC-19 series weighs 25 lbs, holds up to 400lbs
- Ships flat; minimal assembly required
- Accessory bins are sold separately.

Item	Description	Color	UOM	Case
BTUC-17BK	31-7/8"L x 17-1/8"W x 35-7/8"H	Black	Set	1
BTUC-17GY	31-7/8"L x 17-1/8"W x 35-7/8"H	Gray	Set	1
BTUC-19BK	40-1/8"L x 19-3/4"W x 37-3/4"H	Black	Set	1
BTUC-19GY	40-1/8"L x 19-3/4"W x 37-3/4"H	Gray	Set	1
BTUC-179C	Caster for BTUC Series		Each	30
BTUC-179CB	Brake Caster for BTUC Series		Each	30



BTUC-FB

BTUC-RB

Utility Cart Accessory Bin

- For BTUC series

Item	Description	Color	UOM	Case
BTUC-FB	Flatware Bin	Black	Each	6
BTUC-RB	Refuse Bin	Black	Each	3

Foldable Utility Cart

- Heavy-duty 18/8 stainless steel construction holds up to 350 lbs for enhanced durability and long lasting performance.
- Quick and simple fold and unfold for ultimate convenience
- Saves 50% of the space when folded down for effortless transporting and storage; built-on locking buckle keeps the cart folded tightly for added safety.
- Ergonomic handles on both ends allow for full control when maneuvering.
- Skid-resistant shelf surface with 4 non-marking swivel casters, 2 with brake, for safe and easy transporting
- Packing great features in compact size, C.A.C. foldable cart works perfectly from indoor to outdoor, and from front-of-the-house to back-of-the-house with excellent versatility.
- Ships fully assembled

Item	Description	UOM	Case
BTCF-30S	30"L x 16-1/2"W x 36"H	Set	1
BTCF-39S	39"L x 20-3/4"W x 36"H	Set	1
BTCF-309C	Caster for BTCF Series	Each	24
BTCF-309CB	Brake Caster for BTCF Series	Each	24



BTCF-30S



BTCF-39S



Quick and Simple Fold



Easy Transporting



BTDC-6



BTDC-6C BTDC-6CB



Vinyl Cover Included for BTDC-6

Adjustable Dish Caddy

- Great versatility with multiple configurations accommodates up to 300 round plates ranging from 4-1/2" to 13" in diameter.
- Configurable for square plates
- 6 adjustable divider posts included, providing open access to each compartment
- Heavy-duty polyethylene construction ensures excellent durability and protects plates inside from breaking.
- Designed with round corners to avoid damaging walls and furnishings
- 2 front brake casters, 2 large rear casters, and non-slip handles for easy maneuvering
- Vinyl cover included for BTDC-6
- Ships flat and light assembly required
- BTDC-6: ship by freight only; UPS small package not available

Item	Description	UOM	Case
BTDC-6	Gray w/ Vinyl Cover	Set	1
BTDC-6C	Caster for BTDC-6, 10"	Each	20
BTDC-6CB	Brake Caster for BTDC-6, 5"	Each	20
BTDC-6CV	Vinyl Cover for BTDC-6	Each	1

SPECIFICATIONS

BTDC-6	
Dimensions (Fully Assembled)	37-7/8"L x 35-3/4"W x 30"H
Shipping Dimensions	38-3/8" x 36-1/4" x 15-3/4"H
Shipping Weight	91.3lbs

Configurations for Different Sizes of Plates

Follow the suggestions below or mix-match your own configurations!



Plate Dia.	Columns					
9"-13"	-	4	-	-	2	-
7"-9"	2	-	6	-	-	3
5-1/2"-7"	2	-	-	6	-	-
4-1/2"	4	-	-	-	5	5

*Configuration patterns are top views of the caddy when adjusting divider posts. They are not actual parts.



ICCD-126

Mobile Insulated Ice Caddy



- Heavy-duty construction with thick polyurethane foam insulation offers enhanced durability and excellent cold retention for 4-6 hours.
- Large capacity transports and stores up to 126 lbs.
- Sliding lid offers open access for quick and easy operation; slide to close when not in use to help avoid cross-contamination.
- Built-on faucet and water tank quickly separate water from ice and drain away excess water for an extended storage time.
- 4 non-marking casters, 2 with brake, together with sturdy handles enhance mobility and portability and allow for full control when operating.
- Ideal for use in various conditions including indoor, outdoor, hot, humid and more
- No assembly required
- NSF listed
- ICCD-126: ship by freight only; UPS small package not available

Item	Description	UOM	Case
ICCD-126	31-1/2" x 23" x 29-3/8"H	Set	1
ICCD-126C	Caster for ICCD-126, 8"	Each	20
ICCD-126CB	Brake Caster for ICCD-126, 5"	Each	20

Insulated Food Pan Carrier/ Transporter

C.A.C. Insulated Food Pan Carrier Series is ideal to hold and maintain food at proper temperatures for hours, no matter hot or cold, without consuming electricity or any energy. Designed with durable polyethylene exterior and polyurethane foam insulation, the food pan carriers are compatible with standard GN pans, making this series a convenient and efficient solution for central kitchens, bakeries, catering services, outdoor activities, deliveries, and more.

Insulated Food Pan Carrier/ Transporter



- Holds 1/1, 1/2, and 1/3 GN food pans
- Polyurethane foam insulation with airtight gaskets for excellent temperature retention
- Equipped with a vent cap to equalize the pressure inside with outside for easy opening
- Integrated non-slip handles for easy carrying, lifting, moving, and transporting
- Dolly with non-marking casters, built-on or sold separately, for convenient transporting
- Interlockable to meet versatile needs and spacing
- Stackable for easy storage
- NSF listed
- ICTP-2: ship by freight only; UPS small package not available

Item	Description	UOM	Case
ICTP-1	1-Compartment Set	Set	1
ICTP-2	2-Compartment Set	Set	1
ICTP-IDS	Dolly with Strap for ICTP-1	Set	1
ICTP-2C	Caster for ICTP-2, 5"	Each	20
ICTP-2CB	Brake Caster for ICTP-2, 5"	Each	20



Stackable Design



2 ICTP-1 stack with ICTP-IDS



SPECIFICATIONS

Item Number	Dimensions	Holding Capacity		
		1/1 Size Pan	1/2 Size Pan	1/3 Size Pan
ICTP-1	Exterior: 26-3/4" x 18-3/4" x 24-3/8"H Interior: 21-1/8" x 13-1/4" x 19-1/4"H	2-1/2"H x 6pcs 4"H x 4pcs 6"H x 3pcs	4"H x 8pcs 6"H x 4pcs	4"H x 12pcs
ICTP-2	Exterior: 27-1/2" x 20" x 47-1/4"H Interior of Each Compartment: 21-1/8" x 13-1/4" x 17"H	2-1/2"H x 10pcs 4"H x 6pcs 6"H x 4pcs	2-1/2"H x 20pcs 4"H x 12pcs 6"H x 8pcs	4"H x 18pcs 6"H x 12pcs

TEMPERATURE RETENTION

	Starting Temperature	1 HOUR	2 HOUR	3 HOUR	4 HOUR
Heat Retention	188°F	184.3°F	179.5°F	175.7°F	172°F
Cold Retention	32°F	32.8°F	34°F	35.3°F	36.2°F





ICBV-5K



ICTP-3



ICTP-4



ICCD-126K

Beverage Carrier/Dispenser

- 5 gallon/640oz holding capacity
- Excellent temperature retention; holds cold or hot beverages for up to 7 hours
- Built-on faucet for easy dispensing
- Stackable and interlockable, ideal for meeting flexible spacing needs

Item	Description	Size	UOM	Case
ICBV-5K	5 Gallon, Black	16-3/4" x 10-1/4" x 25-1/2"H	Set	1

TEMPERATURE RETENTION

	Starting Temperature	4 HOUR	7 HOUR
Heat Retention	188°F	172°F	162.2°F
Cold Retention	32°F	36.2°F	39.7°F

1-Compartment Insulated Food Pan Carrier



- Holds 1/1, 1/2 and 1/3 GN food pans
- Heavy-duty construction with excellent temperature retention
- NSF listed

Item	Description	UOM	Case
ICTP-3	Black, Extended Top Handle	Set	1
ICTP-4	Gray	Set	1

NSF listing numbers: IFPC-17-BLK, IFPC-32GY

SPECIFICATIONS

Item Number	Overall Dimensions	Holding Capacity		
		1/1 Size Pan	1/2 Size Pan	1/3 Size Pan
ICTP-3	24-1/4" x 16-3/4" x 25-1/4"H	2-1/2"H x 5pcs 4"H x 3pcs 6"H x 2pcs	2-1/2"H x 10pcs 4"H x 6pcs 6"H x 4pcs	2-1/2"H x 15pcs 4"H x 9pcs 6"H x 6pcs
ICTP-4	26-3/8" x 18-1/2" x 24-1/4"H	2-1/2"H x 6pcs 4"H x 4pcs 6"H x 3pcs	4"H x 8pcs 6"H x 4pcs	4"H x 12pcs 6"H x 9pcs

TEMPERATURE RETENTION

	Starting Temperature	1 HOUR	2 HOUR	3 HOUR	4 HOUR
Heat Retention	188°F	184.3°F	179.5°F	175.7°F	172°F
Cold Retention	32°F	32.8°F	34°F	35.3°F	36.2°F

Black Mobile Ice Bin



- Large capacity holds up to 126lbs
- Excellent cold retention for up to 4 hours
- NSF listed
- Ship by freight only; UPS small package not available

Item	Description	UOM	Case
ICCD-126K	30-3/8" x 23-1/4" x 29-1/8"H	Set	1

NSF listing number: IBIN-125-BLK

Electric Urn Coffee Maker

C.A.C. Urn Coffee Maker Series is ideal for fast brewing and high volume coffee dispensing. Constructed with quality stainless steel urn body, this series is an excellent addition for restaurants, catering services, buffets and other large venues.

Deluxe Urn Coffee Maker

- Durable 304 stainless steel percolator pipe and filter basket
- Double-walled stainless steel body; cool-touch handles and locking lid
- Non-drip one-hand dispensing tap
- Interior and exterior water level marks for guidance
- Auto shifts to keep warm and holds at serving temperature
- Built-in heater temperature control; boil-dry prevention control
- Fast brewing with no additional filter required
- ETL listed; meets and complies with electrical safety standards in the U.S.A. (UL-197) and Canada (CAN/CSA-C22.2)
- One-year warranty



BVCM-110

Item	Description	UOM	Case
BVCM-110	108 Cups*/16L	Each	1/2
BVCM-110TP	Tap for BVCM-110	Each	50



Cool-Touch Handle and Locking Lid



Water Level Marks

Urn Coffee Maker

- Durable 304 stainless steel body and percolator pipe
- Cool-touch handles, double-layer lid and non-skid rubber feet
- Non-drip one-hand dispensing tap
- Interior water level marks for guidance
- Built-in heater temperature control; boil-dry prevention control
- Fast brewing with no additional filter required
- ETL listed; meets and complies with electrical safety standards in the U.S.A. (UL-197) and Canada (CAN/CSA-C22.2)
- One-year warranty



BVCM-40

Item	Description	UOM	Case
BVCM-30	30 Cups*/4.5L	Each	1/2
BVCM-40	40 Cups*/6L	Each	1/2
BVCM-340TP	Tap for BVCM-30/40	Each	50

SPECIFICATIONS

	BVCM-110	BVCM-40	BVCM-30
Capacity	108 Cups/16L	40 Cups/6L	30 Cups/4.5L
Color	Silver/Black	Silver/Black	Silver/Black
Dimensions	10-5/8" Dia x 20-1/4"H	7-1/2" Dia x 16-1/2"H	7-1/2" Dia x 14-3/8"H
Voltage	110-120V	110-120V	110-120V
Power	1500W	950W	950W
Frequency	60Hz	60Hz	60Hz
Plug Type	5-15P	5-15P	5-15P
Cord Length	5ft.	3-1/2ft.	3-1/2ft.
Shipping Dimensions	13-3/8" x 13-3/8" x 22-1/4"H	8-7/8" x 8-7/8" x 17-3/8"H	8-7/8" x 8-7/8" x 15-1/8"H
Shipping Weight	12.7lbs	5.1lbs	4.6lbs

* Based on 5-oz cup



Compact Sound Enclosure



MXBD-1500

BlendKing Commercial Blender

BlendKing® Blender Series is designed to meet commercial standard and can crush and blend large volume of ice cubes, frozen fruits, or any mixtures with high efficiency, making this series an essential helper for bars and commercial kitchens.

3.75HP High Power Blender

- Compact sound enclosure reduces decibel exposure during use.
- Removable center lid plug allows easy and continuous ingredient add-ins with included tamper.
- 5oz durable and temperature-resistant BPA-free food grade jug handles large volume of ingredients.
- Industrial grade corrosion-resistant stainless steel blade evenly powers through ice and tough ingredients in seconds.
- 2-in-1 agitator assembly works well with both wet and dry ingredients.
- User-friendly control panel cuts down on operation time.
- Adjustable speed up to 30,000 RPM for improved efficiency.
- ETL listed; meets and complies with electrical safety standards in the U.S.A. (UL-763) and Canada (CAN/CSA-C22.2)
- NSF listed
- One-year warranty



Item	Description	UOM	Case
MXBD-1500	BlendKing 5oz Blender Set	Set	1/1



MXBD-68

2.5HP Professional Blender

- Removable center lid plug allows easy and continuous ingredient add-ins with included tamper.
- 68oz durable and temperature-resistant BPA-free food grade jug handles large volume of ingredients.
- Industrial grade corrosion-resistant stainless steel blade evenly powers through ice and tough ingredients in seconds.
- 2-in-1 agitator assembly works well with both wet and dry ingredients.
- User-friendly control panel cuts down on operation time.
- Adjustable speed range 27,000- 30,000 RPM for improved efficiency.
- ETL listed; meets and complies with electrical safety standards in the U.S.A. (UL-763) and Canada (CAN/CSA-C22.2)
- NSF listed
- One-year warranty



Item	Description	UOM	Case
MXBD-68	BlendKing 68oz Blender Set	Set	1/1



Industrial Grade
Stainless Steel Blade



BPA-Free
Food Grade Jug

3.75HP Digital High Power Blender

- Compact sound enclosure is included to reduce decibel exposure during use.
- User-friendly digital panel offers precise speed control and consistent results.
- Removable center lid plug allows easy and continuous ingredient add-ins with included tamper.
- 51oz durable and temperature-resistant BPA-free food grade jug handles large volume of ingredients.
- Industrial grade corrosion-resistant stainless steel blade evenly powers through ice and tough ingredients in seconds.
- 2-in-1 agitator assembly works well with both wet and dry ingredients.
- 4 speed settings allow up to 30,000 RPM for improved efficiency.
- ETL listed; meets and complies with electrical safety standards in the U.S.A. (UL-763) and Canada (CAN/CSA-C22.2)
- NSF listed
- One-year warranty



Compact Sound Enclosure



MXBD-DIG150

Item	Description	UOM	Case
MXBD-DIG150	BlendKing 51oz Digital Blender Set	Set	1/1

SPECIFICATIONS

	MXBD-DIG150	MXBD-1500	MXBD-68
Capacity	51oz/1500ml	51oz/1500ml	68oz/2000ml
Color	Black/Clear	Black/Clear	Black/Clear
Base Dimensions	8-1/2"L x 10-3/4"W	8-1/2"L x 10-3/4"W	9-1/4"L x 10-3/8"W
Max Height	25-5/8"	25-5/8"	20-1/2"
Voltage	110-120V	110-120V	110-120V
Power	1800W	1800W	1500W
Horsepower	3.75hp-Peak	3.75hp-Peak	2.5hp-Peak
RPM	Up to 30,000	Up to 30,000	27,000-30,000
Frequency	60Hz	60Hz	60Hz
Plug Type	NEMA 5-15P	NEMA 5-15P	NEMA 5-15P
Cord Length	4-3/4ft.	4-3/4ft.	3-3/4ft.
Shipping Dimensions	13-7/8" x 11-1/8" x 21-1/8"H	13-7/8" x 11-1/8" x 21-1/8"H	19-1/4" x 12-5/8" x 13-3/4"H
Shipping Weight	19.8lbs	19.8lbs	16.5lbs

Accessory

- NSF listed: MXBD-68RJAS, MXBD-150RJAS



Item	Description	MXBD-DIG150	MXBD-1500	MXBD-68	UOM	Case
MXBD-68PG	Lid Plug for 68oz Jug			•	Each	1
MXBD-150PG	Lid Plug for 51oz Jug	•	•		Each	1
MXBD-68LD	Lid for 68oz Jug			•	Each	1
MXBD-150LD	Lid for 51oz Jug	•	•		Each	1
MXBD-68TMP	Tamper for 68oz Jug			•	Each	1
MXBD-150TMP	Tamper for 51oz Jug	•	•		Each	1
MXBD-68RJAS	Jug Assembly 68oz			•	Each	1/4
MXBD-150RJAS	Jug Assembly 51oz	•	•		Each	1/4



MXBD-68RJAS



MXBD-150RJAS



MXBD-68PG

MXBD-68LD



MXBD-68TMP



MXBD-150PG

MXBD-150LD



MXBD-150TMP



ELWP-1



ELWP-1 with 1/1 Size GN Pan
*GN pan sold separately



ELWP-1 & CAFR-501

Compatible with
Our Full Size Chafer

Electric Water Pan

- Durable and rust-resistant polypropylene construction for long-lasting performance
- Flame-free hot holding solution helps to keep food warm during service.
- Heats and keeps water up to 185°F/85°C; meets and exceeds HACCP food-safe reheating and hot-holding temperature requirements.
- Thermostat knob on the control panel helps to adjust temperature while in use.
- Maximized versatility allows for operating by itself or pairing with other full size chafer frames.
- Compatible with standard GN pan (sold separately).
- ETL listed; meets and complies with electrical safety standards in the U.S.A. (UL-197) and Canada (CAN/CSA-C22.2)
- One-year warranty

Item	Description	UOM	Case
ELWP-1	Full Size, Black	Each	1

SPECIFICATIONS

Capacity	1/1 size food pan x 1 or 1/2 size food pan x 2
Color	Black
Dimensions	22-5/8"L x 13-3/4"W x 7"H
Voltage	120V
Power	900W
Frequency	60Hz
Plug Type	NEMA 5-15P
Cord Length	5ft.
Temperature Range	185°F/85°C-Max
Shipping Dimensions	22-7/8" x 14-5/8" x 7-7/8"H
Shipping Weight	6.6lbs

Butane Stove

Designed with high-quality solid brass burner, C.A.C. Portable Butane Stove is able to offer optimal power output and long-lasting performance with compact size. Packing 9,500BTU with a metal body, this butane stove comes with a myriad of great features, which make it perfect for indoor/outdoor catering services, parties, buffets, camping, tableside display cooking and more.



BTST-SK



Single Burner Butane Stove

- Advanced solid brass burner offers exceptional rust- and temperature-resistance; high-power output up to 9,500BTU/hour.
- Built-in safety locking lever; heat-resistant knob; iron drip pan and grate; wind baffle
- Appliance-style control knob helps to adjust temperature easily and precisely.
- Enamel-coated iron drip pan catches spills and reflects heat back to cookware.
- Built-in over pressure protection and auto-off
- Commercial grade heavy-duty carrying case included
- Compatible with 8-oz butane canister (sold separately)
- Perfect for indoor and outdoor use
- CSA listed for use with butane gas, commercial indoor or outdoor operation in the U.S.A. and Canada
- One-year warranty



Item	Description	UOM	Case
BTST-SK	9,500BTU	Each	1/6



Solid Brass Burner



Conventional Control Panel

Hot Dog Roller Grill

Constructed with heavy-duty stainless steel base and rollers, C.A.C. Hot Dog Roller Grill Series offers a safe, reliable, and convenient solution to roll and grill hot dogs, sausages, taquitos, egg rolls and more with high efficiency. Simple and professional appearance goes well with any commercial settings such as convenient stores, food trucks, meetings, parties, and sport events.

Hot Dog Roller Grill

- Fresh and juicy hot dog grab-and-go
- Dual-heating thermostats control the front and rear rollers independently, allowing for cooking on one side and keeping warm on the other.
- Quality motor continuously rotates the rollers for even heat distribution.
- Sealed roller ends protect motor and other internal parts from grease for increased safety and easy maintenance.
- Removable drip tray catches grease and crumbs during use for easy cleaning.
- Sneeze guard included in the set for protection against splashes
- Non-skid rubber feet for stable countertop operation
- ETL listed; meets and complies with electrical safety standards in the U.S.A. (UL-197) and Canada (CAN/CSA-C22.2)
- ETL sanitation listed; complies with NSF/ANSI-4
- One-year warranty



HDRS-05



HDRS-07



HDRS-09



HDRS-11N

Item	Description	UOM	Case
HDRS-05	5-Roller Set w/ Sneeze Guard	Set	1
HDRS-07	7-Roller Set w/ Sneeze Guard	Set	1
HDRS-09	9-Roller Set w/ Sneeze Guard	Set	1
HDRS-11N	11-Roller Set w/ Sneeze Guard	Set	1

SPECIFICATIONS

	HDRS-05	HDRS-07	HDRS-09	HDRS-11N
Roller	5	7	9	11
Max Hot Dog Capacity*	12	18	24	30
Non-Stick Coating	-	-	-	Yes
Dimensions (Fully Assembled)	23"L x 10-5/8"W x 15"H	23"L x 13-5/8"W x 16"H	23"L x 16-3/8"W x 16"H	23"L x 19-7/8"W x 16-1/2"H
Voltage	110V	110V	110V	110V
Power	700W	900W	1200W	1400W
Frequency	60Hz	60Hz	60Hz	60Hz
Plug Type	NEMA 5-15P	NEMA 5-15P	NEMA 5-15P	NEMA 5-15P
Cord Length	6ft.	6ft.	6ft.	6ft.
Shipping Dimensions	26" x 14-3/8" x 13-1/2"H	26" x 17-1/8" x 14-1/4"H	26" x 19-1/2" x 14-7/8"H	26" x 23" x 15-1/4"H
Shipping Weight	24.5lbs	30.5lbs	37.5lbs	44.1lbs

* Numbers may vary when rolling different items.



Electric Heat Lamp

- Heavy-duty aluminum construction with self-standing base
- Bottom opening fits standard GN pan up to full size.
- Adjustable post helps to keep food at ready-to-serve temperatures and avoid over-drying.
- 2 shatter-proof clear bulbs included in the set
- ETL listed; meets and complies with electrical safety standards in the U.S.A. (UL-197) and Canada (CAN/CSA-C22.2)
- One-year warranty



ELHL-1

Item	Description	UOM	Case
ELHL-1	Electric Heat Lamp	Set	1
ELHL-1CL	Clear Bulb for ELHL-1	Each	1/24
ELHL-1RD	Red Bulb for ELHL-1	Each	1/24

SPECIFICATIONS

Color	Silver
Overall Dimensions	16-3/4"L x 13-3/4"W x 30-3/4"H
Clearance Under Bulb	14" to 22"
Voltage	110V
Power	500W, 250W/Bulb
Frequency	60Hz
Plug Type	NEMA 5-15P
Cord Length	5-1/2ft.
Shipping Dimensions	19-1/2" x 13-1/4" x 7"H
Shipping Weight	12.1lbs

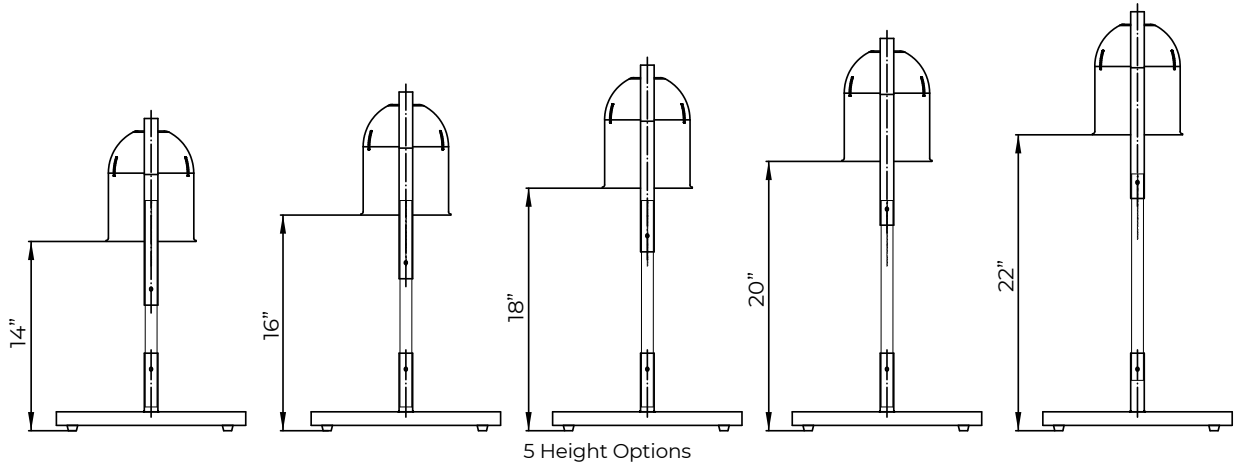

Induction Cooker

C.A.C. Commercial Induction Cooker Series features SCHOTT CERAN® glass surface for optimal durability, temperature resistance and energy efficiency. Designed with German glass-ceramic technology, the glass surface is able to withstand sudden temperature shocks up to 1,380°F/750°C and intensive use of a busy commercial kitchen. Effectively concentrating the heat in a confined area of surface while keeping the rest of surface relatively cool, C.A.C. induction cooker helps achieve cooking safety and energy saving.



High-Power Commercial Induction Cooker

- The appliance beeps as a safety alert if the glass surface does not detect a suitable induction-ready cookware.
- ETL listed; meets and complies with electrical safety standards in the U.S.A. (UL-197)
- One-year warranty



Item	Description	UOM	Case
ELIC-1200G	3500W, 240V	Each	1/2

Commercial Induction Cooker

- The appliance beeps as a safety alert if the glass surface does not detect a suitable induction-ready cookware.
- ETL listed; meets and complies with electrical safety standards in the U.S.A. (UL-197)
- ETL sanitation listed; complies with NSF/ANSI-4
- One-year warranty



Item	Description	UOM	Case
ELIC-600G	1800W, 120V	Each	1/2



ELIC-600G

 Check full line of induction-ready cookware on page 78.

■ SPECIFICATIONS

	ELIC-600G	ELIC-1200G
Dimensions	12-5/8" L x 16-1/2" W x 3-7/8" H	12-5/8" L x 16-1/2" W x 3-7/8" H
Voltage	120V	240V
Power	1800W	3500W
Frequency	60Hz	60Hz
Plug Type	NEMA 5-15P	NEMA 6-20P
Shipping Dimensions	15" x 5-1/2" x 18-3/4" H	15" x 5-1/2" x 18-3/4" H
Shipping Weight	14lbs	14lbs



Electric Countertop Warmer

C.A.C. Electric Countertop Warmer Series offers a simple yet versatile solution for holding food, soup, stews, sauces or gravies at food-safe and ready-to-serve temperatures. Packing loads of great features in compact sizes, C.A.C. Electric Countertop Warmer Series is an excellent addition for restaurants, catering services, buffet or other venues.



Food Warmer

- Commercial-grade stainless steel body and water tank for exceptional durability and corrosion-resistance
- High power for fast heating
- Adjustable knob helps to hold ready-to-serve temperatures and avoid burning.
- Full-size well opening allows for flexible and customized configurations of standard GN steam table pans up to 6" deep.
- ETL listed; meets and complies with electrical safety standards in the U.S.A. (UL-197) and Canada (CAN/CSA-C22.2)
- ETL sanitation listed; complies with NSF/ANSI-4
- One-year warranty

Item	Description	UOM	Case
ELFW-1200	Full Size up to 6" Deep	Set	1
ELFW-1500	Full Size up to 6" Deep, Vented Exterior	Set	1
ELFW-1250KB	Knob for ELFW-1500/1200	Each	50

Check full line of GN steam table pans on page 72.



ELFW-1200



ELFW-1500



■ SPECIFICATIONS

	ELFW-1200	ELFW-1500
Capacity	Full Size	Full Size
Color	Silver	Silver
Dimensions	Exterior: 21-1/4"L x 13-1/4"W x 9-1/2"H Interior: 20"L x 12"W x 6-1/4"H	Exterior: 22-3/8"L x 14-1/2"W x 9-1/2"H Interior: 20"L x 12"W x 6-1/4"H
Voltage	110V	110V
Power	1200W	1200W
Frequency	60Hz	60Hz
Plug Type	NEMA 5-15P	NEMA 5-15P
Cord Length	5-1/4ft.	5-1/4ft.
Shipping Dimensions	25" x 15-1/4" x 11-1/4"H	26" x 16-3/4" x 11-1/4"H
Shipping Weight	17.6lbs	17.6lbs



Soup Warmer

- 304 stainless steel hinged lid and seamless inset for enhanced durability
- Adjustable dial helps to hold ready-to-serve temperatures and avoid burning.
- Preprinted soup/stew name tags and magnetic tag holder included
- ETL listed; meets and complies with electrical safety standards in the U.S.A. (UL-197) and Canada (CAN/CSA-C22.2)
- ETL sanitation listed; complies with NSF/ANSI-4
- One-year warranty

Item	Description	Color	UOM	Case
ELSW-100K	10.5QT	Black	Set	1
ELSW-200S	10.5QT	Silver	Set	1
ELSW-INS	Inset for ELSW Series	-	Each	2
ELSW-CV	Cover for ELSW Series	-	Each	6/24
ELSW-120KB	Knob for ELSW-100K/200S	-	Each	50



ELSW-100K



ELSW-200S



■ SPECIFICATIONS

	ELSW-100K	ELSW-200S
Capacity	10.5QT	10.5QT
Color	Black	Silver
Dimensions	12-1/2"Dia x 14"H	12-1/2"Dia x 14"H
Voltage	110-120V	110-120V
Power	400W	400W
Frequency	60Hz	60Hz
Plug Type	NEMA 5-15P	NEMA 5-15P
Cord Length	5-1/2ft.	5-1/2ft.
Shipping Dimensions	13-1/2" x 13-1/2" x 15-1/2"H	13-1/2" x 13-1/2" x 15-1/2"H
Shipping Weight	12.5lbs	12.5lbs



RFCS-27B



Built-in Lock with 2 Keys Included



Countertop Display Refrigerator

- Compact countertop merchandising refrigerator with clear glass door and interior LED lighting, ideal to display and showcase bottled drinks.
- Black-coated steel exterior allows for enhanced durability with a sleek look.
- Foam-in-place polyurethane insulation for excellent temperature retention
- Advanced R600a refrigerant delivers superior thermodynamic performance and low environmental impact.
- 3 removable shelves for maximized space utilization and easy maintenance
- Built-in lock safely keeps merchandising items inside; 2 keys are included in the set.
- ETL listed; meets and complies with electrical safety standards in the U.S.A. (UL-471) and Canada (CAN/CSA-C22.2)
- ETL sanitation listed; complies with NSF 7
- One-year warranty plus three-year compressor warranty



Item	Description	UOM	Case
RFCS-27B	Black	Set	1

SPECIFICATIONS

Net Volume	68L/2.4 cu.ft.
Lighting	Interior LED
Color	Black
Insulation	Foamed-in-place polyurethane
Overall Dimensions	18-3/4"L x 17-1/8"W x 27"H
Shelf Dimensions	Top 2 shelves: 14-1/8"L x 12-5/8"W Bottom shelf: 14-1/8"L x 9-1/2"W
Shelf Load Capacity	33lbs per shelf
Shelf Material	PVC coated iron
Voltage	110-120V
Amps	1.6A
Power	80W
Frequency	60Hz
Phase	2-Phase
Plug Type	NEMA 5-15P
Cord Length	5ft.
Refrigerant	R600a
Temperature Range	32-50°F/0-10°C
Defrosting	Manual
Ambient Temperature	90°F-Max
Temperature Controller	Mechanical
Shipping Dimensions	22-7/8" x 20-1/2" x 29-1/4"H
Shipping Weight	57.3lbs

Countertop Convection Oven

C.A.C. Countertop Convection Oven Series is designed with heavy-duty stainless steel construction and fully-insulated double-wall body for long lasting performance and excellent heat retention. Equipped with a powerful fan and exhaust system that circulate hot air evenly and quickly, C.A.C. Countertop Convection Oven Series provides fast and even results and is ideal for cooking, warming, baking, and browning with optimal versatility and improved efficiency.

- Heavy-duty, stain- and corrosion-resistant stainless steel body
- Dual-pane glass door for enhanced heat-retention and clear visibility
- Wide temperature range of 150-500°F with a timer control for up to 120 minutes
- Fits standard sheet pans
- One-year limited warranty
- ETL listed; meets and complies with electrical safety standards in the U.S.A. (UL-197) and Canada (CAN/CSA-C22.2)
- ETL sanitation listed; complies with NSF 4

Half Size Convection Oven

- Fits up to 4 half size sheet pans
- 4 baking racks included



Item	Description	UOM	Case
OVCT-H2	Half Size	Set	1

Quarter Size Convection Oven

- Fits up to 3 quarter size sheet pans
- 3 baking racks included



Item	Description	UOM	Case
OVCT-Q1	Quarter Size	Set	1



OVCT-H2



OVCT-Q1

SPECIFICATIONS

	OVCT-H2	OVCT-Q1
Net Volume	1.6 cu.ft.	0.9 cu.ft.
Size	Half Size	Quarter Size
Capacity	(4) 1/2 Size Sheet Pans ⬇️	(3) 1/4 Size Sheet Pans ⬇️
Oven Type	Convection	Convection
Temperature Range	150-500°F	150-500°F
Phase	1-Phase	1-Phase
Overall Dimensions	22-7/8"L x 22-1/2"W x 16"H	19-3/4"L x 18-3/4"W x 15"H
Interior Dimensions	18-1/2"L x 15-1/2"W x 9-7/8"H	14-1/8"L x 13"W x 8-5/8"H
Rack Dimensions	18-1/8"L x 13"W	13-3/4"L x 11"W
Rack Material	Chrome-plated steel	Chrome-plated steel
Voltage	120V	120V
Amps	13.3A	12A
Power	1600W	1440W
Frequency	60Hz	60Hz
Plug Type	NEMA 5-15P	NEMA 5-15P
Cord Length	6ft.	6ft.
Shipping Dimensions	25-5/8" x 25-5/8" x 18-1/4"H	22-1/4" x 22-1/4" x 17-7/8"H
Shipping Weight	59.5lbs	38.8lbs



Interior of OVCT-Q1
*Contents not included



OVCT-H2
*Contents not included

⚠️ Check C.A.C. ASHP Series for compatible sheet pans.

Merchandising Display Case

C.A.C. Display Case Series offers refrigerated and heated merchandising solutions to keep food fresh and safe with excellent showcase visibility and easy access, making this series perfect for supermarkets, cafeterias, pizza stores, convenience stores or other venues.



HTCS-31RT-SL 

Heated Rotating Display Case Set

- Stainless steel plus reinforced glass construction for long-lasting performance
- Temperature range 85-195°F/30-90°C with adjustable thermostat
- Removable water pan included for easy humidity control
- Rotating chrome-plated display rack included and holds 4 levels of 14" pizza.
- Display panel with light box for maximized branding and merchandising visibility
- Display rack starts rotating when door is securely closed and immediately stops rotating when door is opened.
- ETL listed; meets and complies with electrical safety standards in the U.S.A. (UL-197) and Canada (CAN/CSA-C22.2)
- ETL sanitation listed; complies with NSF 4
- One-year warranty
- Ship by freight only; UPS small package not available



Item	Description	UOM	Case
HTCS-31RT-SL	Rotating Heated Display Case	Set	1



HTCS-26GY 

Heated Display Case Set

- Heavy-duty metal construction for exceptional durability
- Temperature range 85-195°F/30-90°C with adjustable thermostat and clear temperature display
- 2 reinforced glass doors open in front and back for easy access and maintenance
- 3-tier adjustable chrome-plated shelves (included) plus the top allow for 4 levels of spacing
- Display panel with light box for maximum branding and merchandising visibility
- LED internal illumination for enhanced energy-efficiency and maximized display visibility
- ETL listed; meets and complies with electrical safety standards in the U.S.A. (UL-197) and Canada (CAN/CSA-C22.2)
- ETL sanitation listed; complies with NSF 4
- One-year warranty
- Ship by freight only; UPS small package not available



Item	Description	UOM	Case
HTCS-26GY	Heated Display Case	Set	1

■ SPECIFICATIONS

	HTCS-31RT-SL	HTCS-26GY
Net Volume	3.43 cu. ft./97L-Max	2.69 cu. ft./76L-Max
Color	Silver/Clear	Black/Clear
Dimensions	18"L x 17-1/2"W x 31"H	13-5/8"L x 19"W x 26"H
Internal Dimensions	17-3/4"L x 16-1/2"W x 21-5/8"H	Top: 11-3/8"L x 12"W Bottom: 11-3/8"L x 18-1/2"W Height: 15-7/8"H
Shelf Dimensions	14-1/4"Dia	Top: 11-3/8"L x 11-1/4"W Middle: 11-3/8"L x 12-1/2"W Bottom: 11-3/8"L x 13-5/8"W
Power	786W	800W
Voltage	110-120V	110-120V
Amps	7.2A	7.6A
Frequency	60Hz	60Hz
Plug Type	NEMA 5-15P	NEMA 5-15P
Temperature Range	85-195°F/30-90°C	85-195°F/30-90°C
Temperature Controller	Mechanical	Mechanical
Shelf Material	Chrome-plated steel	Chrome-plated steel
Shipping Dimensions	21-1/8" x 21" x 32-3/4"H	21-3/4" x 16-1/8" x 27-3/8"H
Shipping Weight	53lbs	50.7lbs

Refrigerated Display Case Set

- Heavy-duty metal construction for exceptional durability
- Temperature range 32-54°F/0-12°C with digital display
- 2 reinforced glass doors open in front and back for easy access and maintenance
- 3-tier adjustable chrome-plated shelves are included and allow for 4 levels of spacing.
- 4 LED light strips for enhanced energy-efficiency and maximum display visibility
- Environmentally-friendly R290 refrigerant
- ETL listed; meets and complies with electrical safety standards in the U.S.A. (UL-471) and Canada (CAN/CSA-C22.2)
- ETL sanitation listed; complies with NSF 7
- One-year warranty
- Ship by freight only; UPS small package not available



Item	Description	UOM	Case
RFCS-39WT	White Case Set	Set	1
RFCS-39BK	Black Case Set	Set	1

SPECIFICATIONS

	RFCS-39WT	RFCS-39BK
Net Volume	3.04 cu. ft.-Max	3.04 cu. ft.-Max
Color	White	Black
Dimensions	Exterior: 17"L x 17"W x 39"H Shelf: 14-3/8"L x 12-1/8"W	Exterior: 17"L x 17"W x 39"H Shelf: 14-3/8"L x 12-1/8"W
Power	190W	190W
Voltage	110-120V	110-120V
Amps	1.7A	1.7A
Frequency	60Hz	60Hz
Plug Type	NEMA 5-15P	NEMA 5-15P
Refrigerant	R290	R290
Defrosting	Automatic	Automatic
Ambient Temperature	90°F-Max	90°F-Max
Temperature Range	32-54°F/0-12°C	32-54°F/0-12°C
Temperature Controller	Digital	Digital
Shelf Material	Chrome-plated steel	Chrome-plated steel
Shipping Dimensions	18-7/8" x 18-7/8" x 40-3/4"H	18-7/8" x 18-7/8" x 40-3/4"H
Shipping Weight	86lbs	86lbs



RFCS-39WT 



RFCS-39BK 